

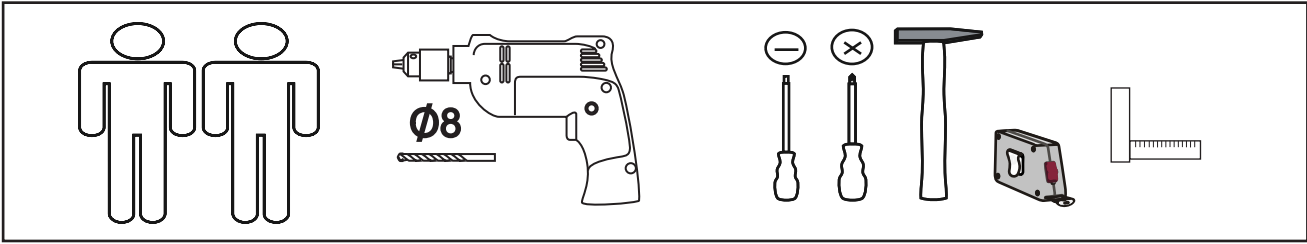









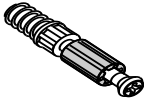
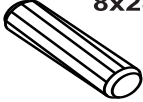





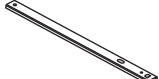

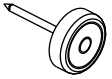
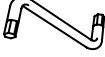
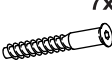

# Optimus 05

# 38005\_\_N / 38005\_\_F



 10x T02	 10x T01	 8x28 D01	 4x KR-15 Z01	 6x Z02	 12x E01
 2x 4x13 W07	 2x KR-08 Z03	 4x P03	 8x 6x8 W10	 1x E02	 16x R01
 5x U01	 10x 4x25 W01	 5x S01	 1x K01	 2x 7x50 W04	 1x L01
 4x 4x10 X02	 12x 3,5x15 W03	 1x F01	 1x F11	 1x P01	

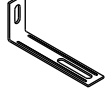
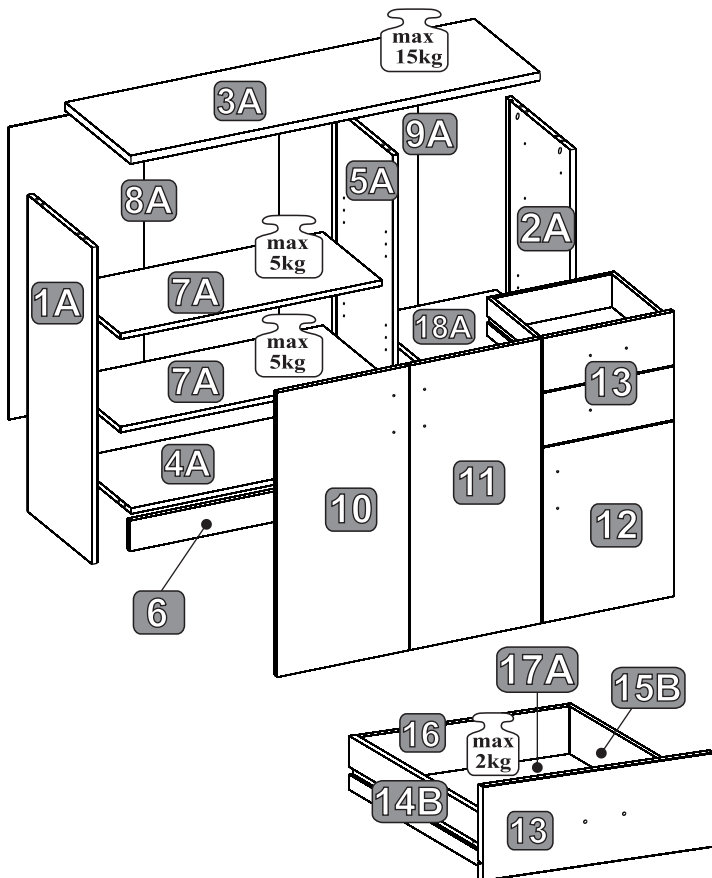

NR	DIM	QTE	COLLI
1A	828x345x15	1	1/1
2A	828x345x15	1	1/1
3A	1092x352x22	1	1/1
4A	1061x323x15	1	1/1
5A	733x322x15	1	1/1
6	1061x80x15	1	1/1
7A	698x296x15	2	1/1
8A	752x711x2	1	1/1
9A	752x360x2	1	1/1
10	744x350x15	1	1/1
11	744x350x15	1	1/1
12	458x350x15	1	1/1
13	350x140x15	2	1/1
14B	290x100x12	2	1/1
15B	290x100x12	2	1/1
16	315x100x12	2	1/1
17A	326x290x2	2	1/1
18A	347x296x15	1	1/1



# 1

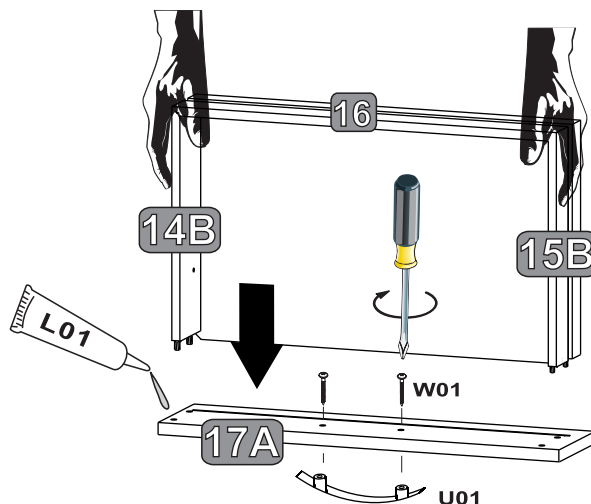
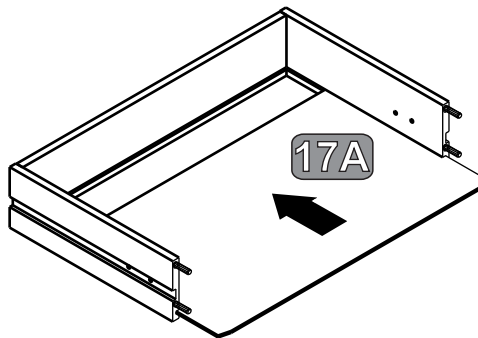
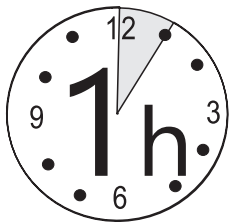
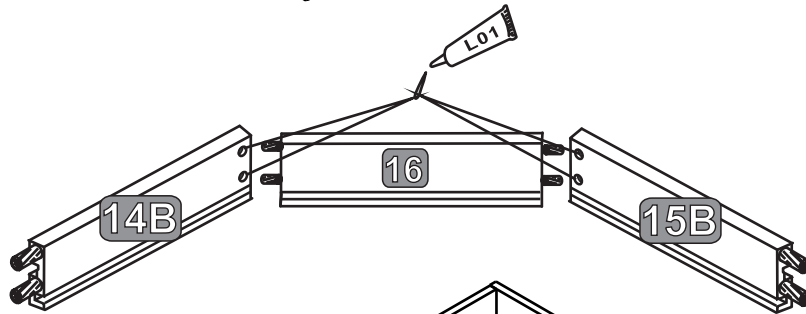
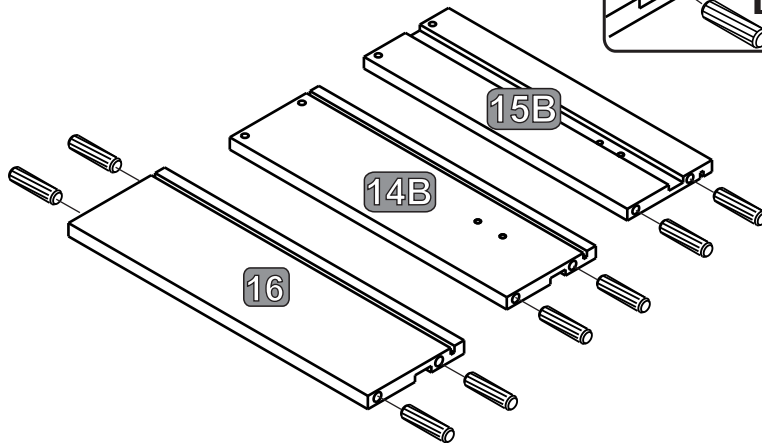
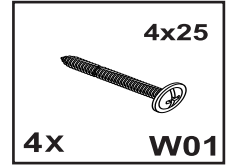
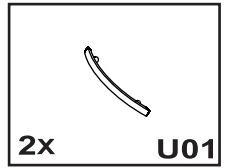
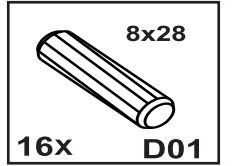
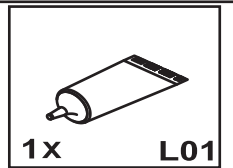
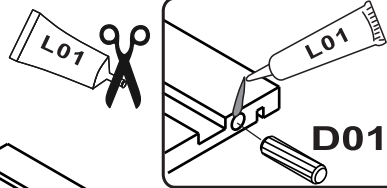
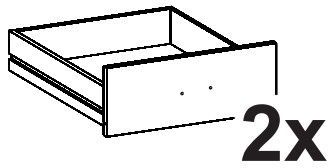

## 2

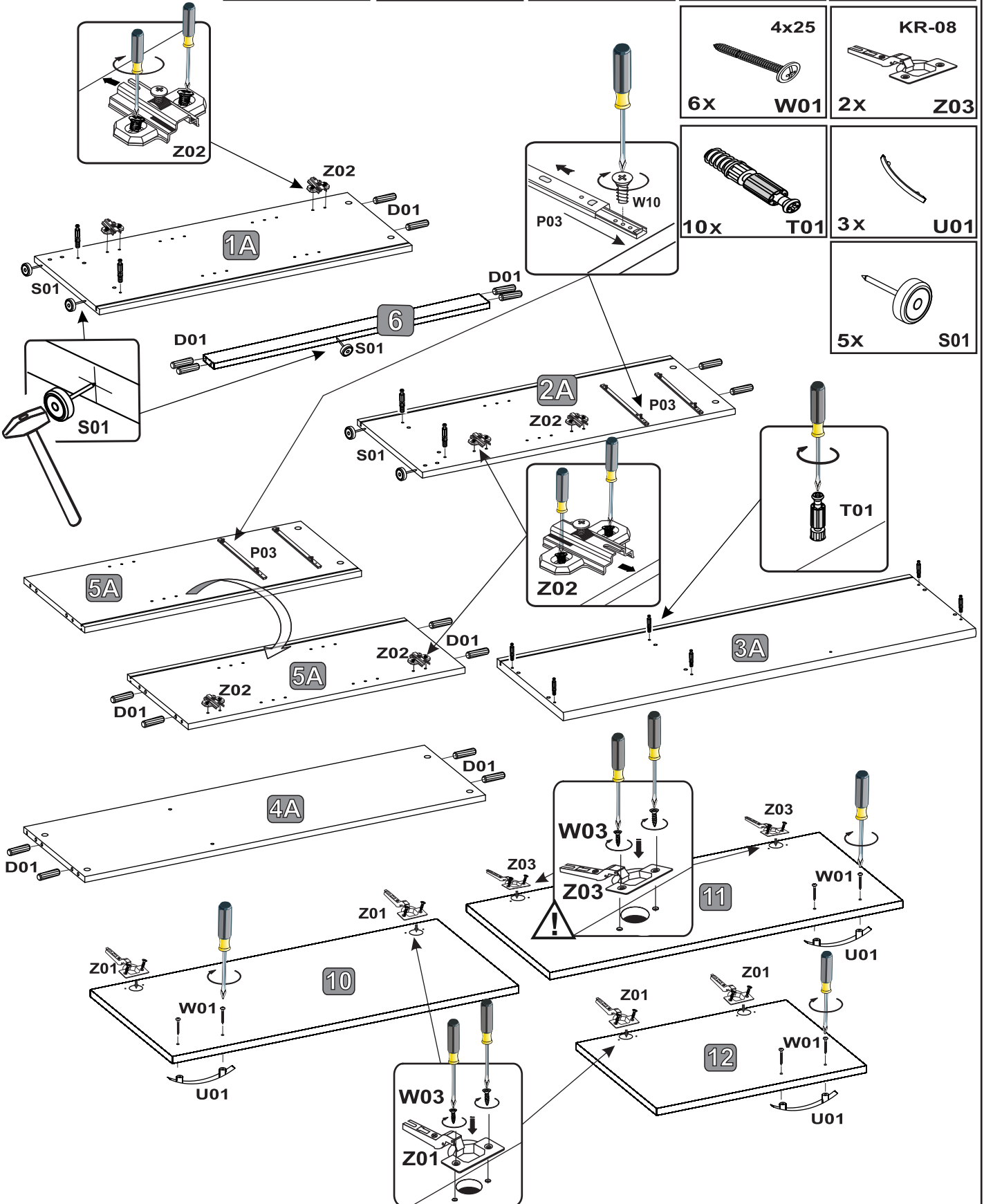
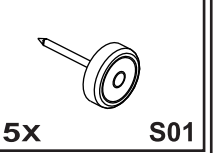
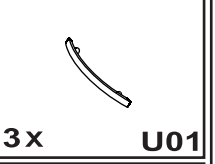
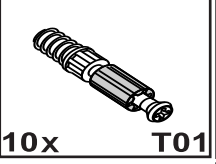
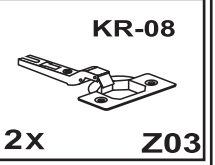
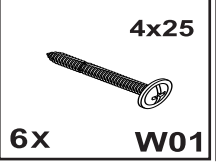
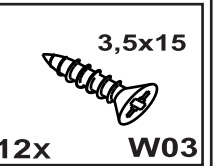
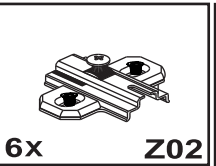
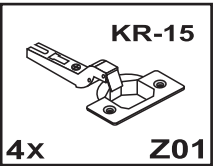
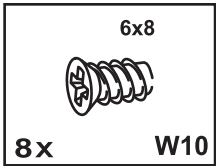
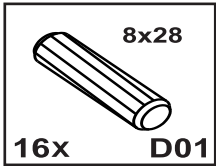
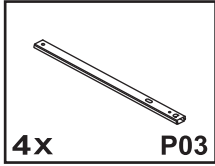

## 3

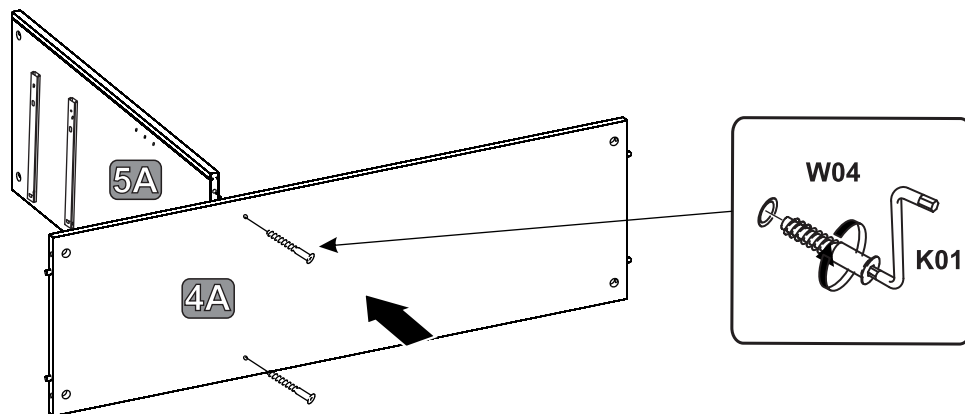

1x K01

7x50  
2x W04

## 4

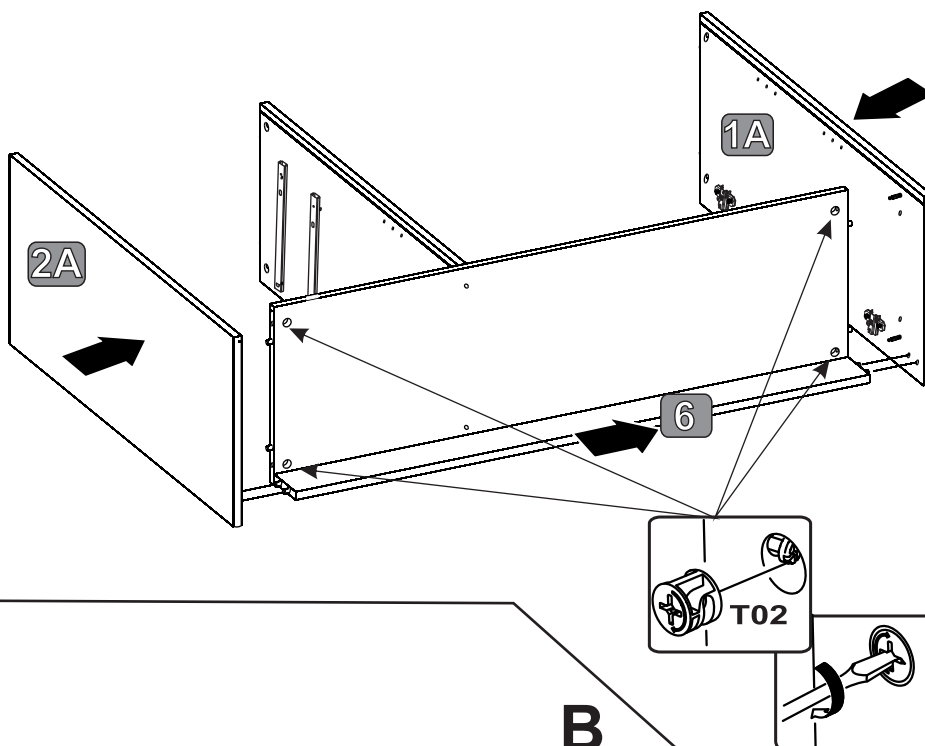

4x T02

## 5

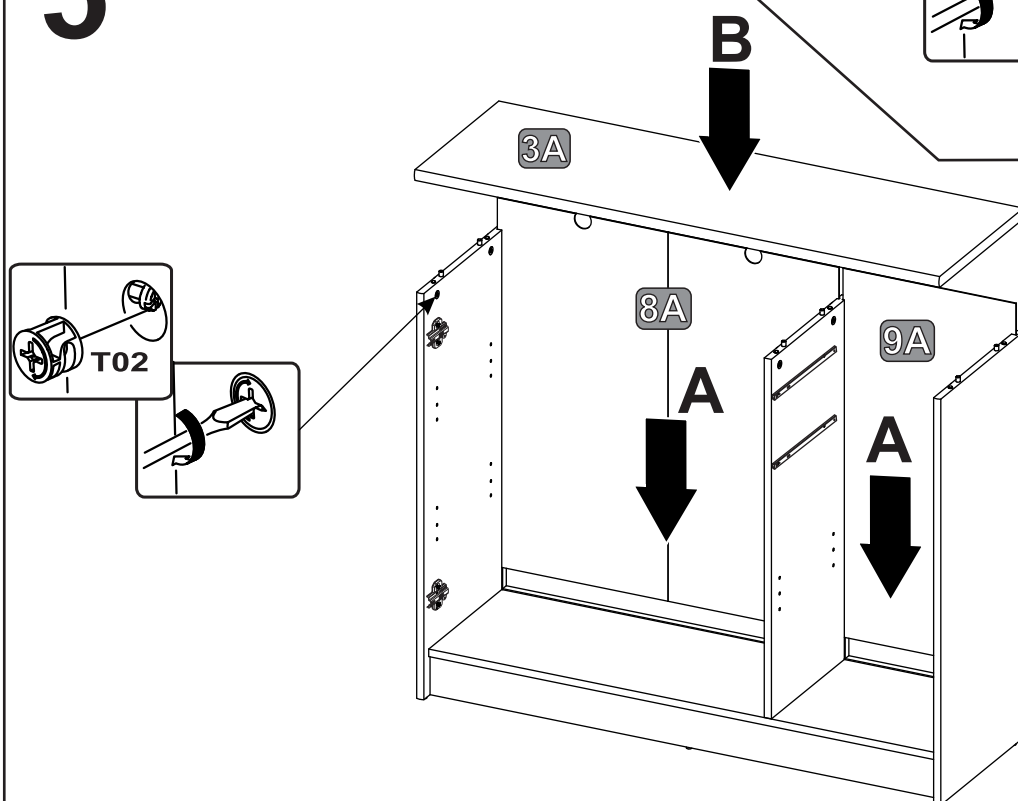

6x T02

6

A=B

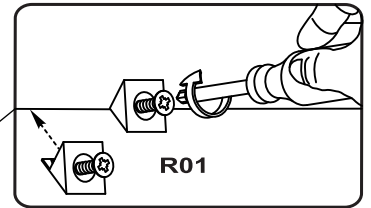
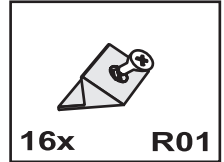
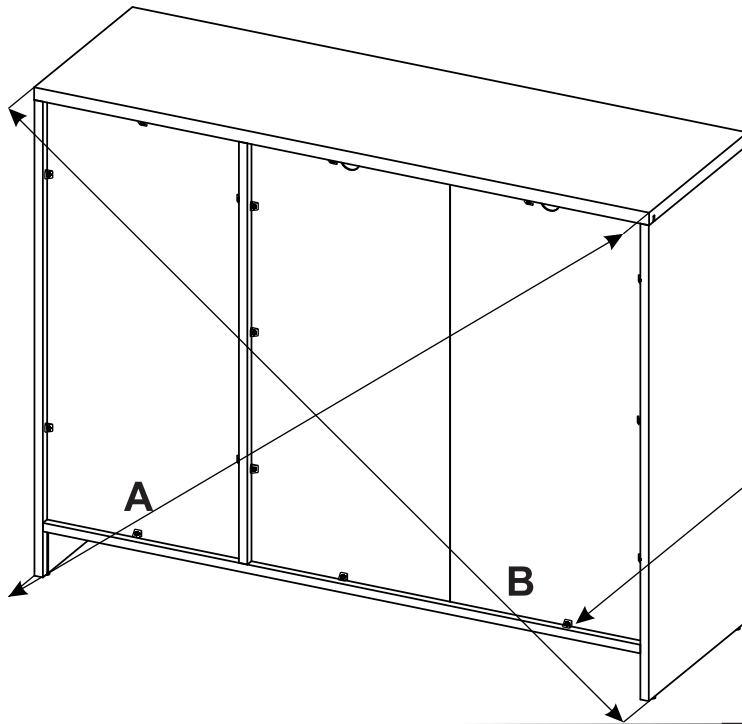

7

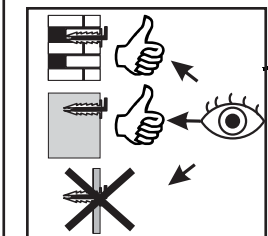
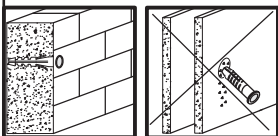
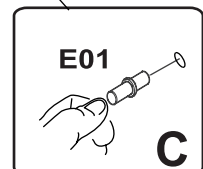
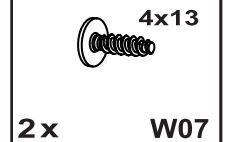
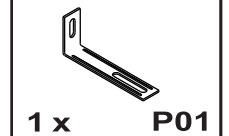
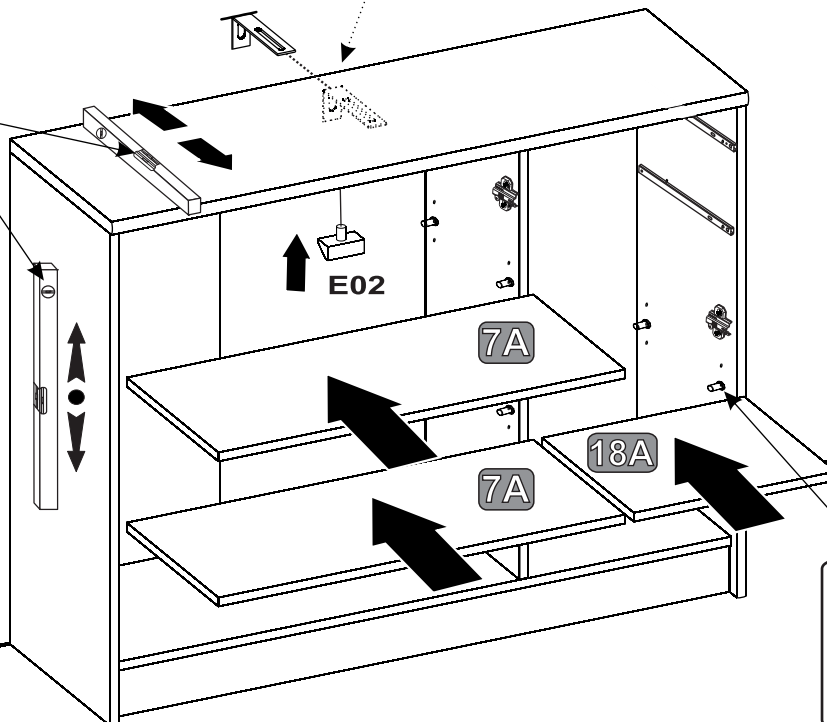
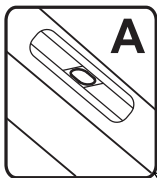
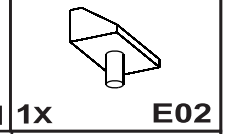
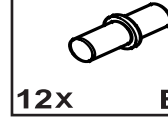
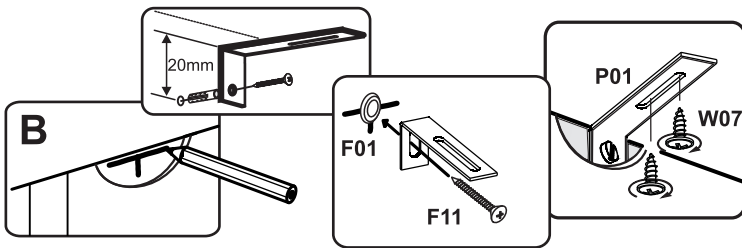

8

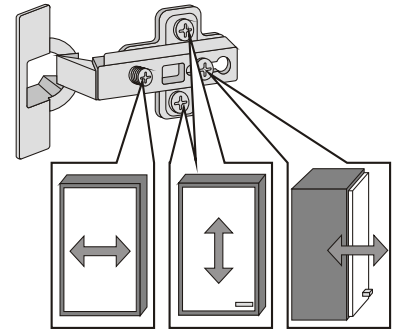
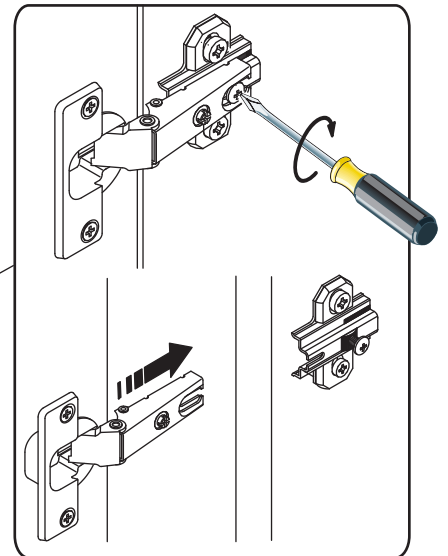
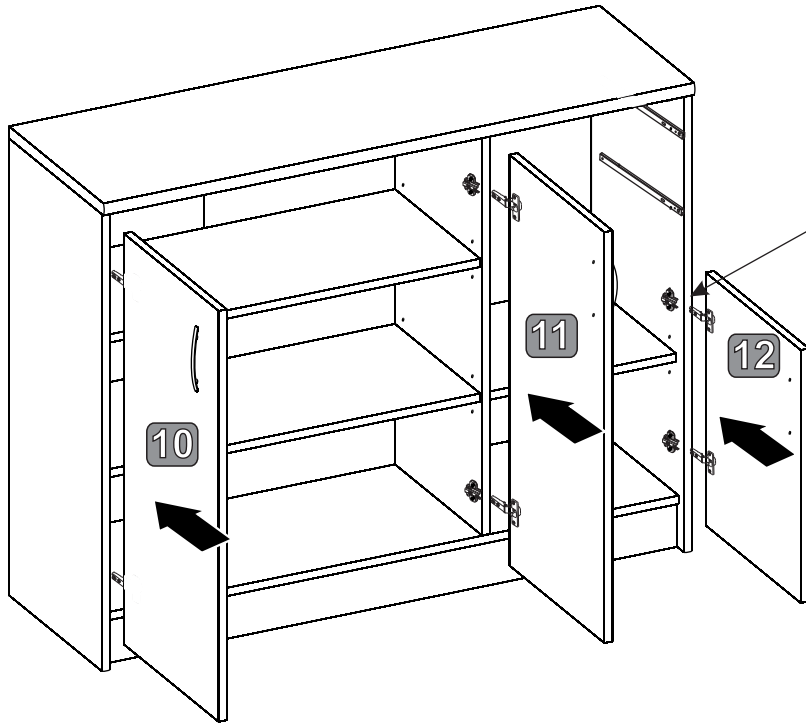

9

