

A

S551-POL

10M6--40

1 / 4

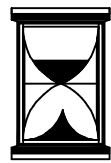
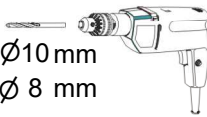
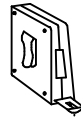
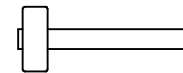
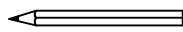
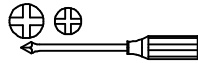
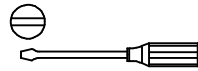
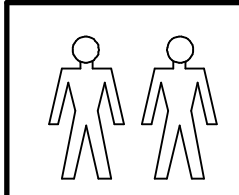
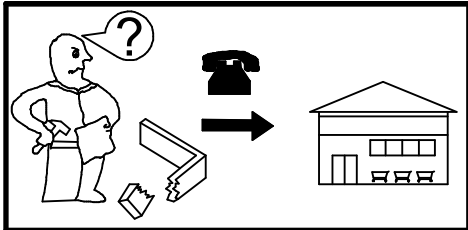
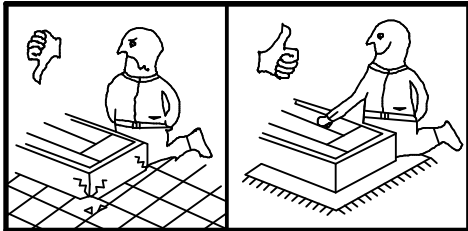
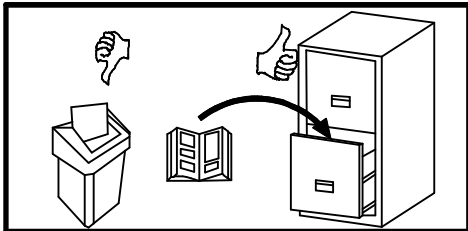
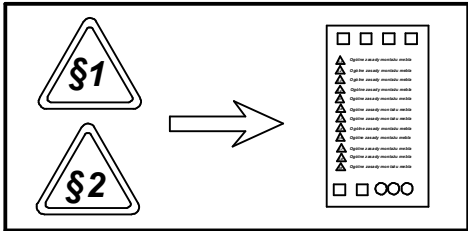
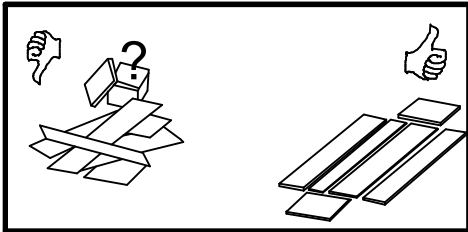
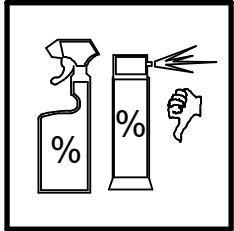

30min

A	B	C1	C2	C3	D
1	S551-3022	1725	200	22	1/1
2	S551-4011	1845	250	16	1/1

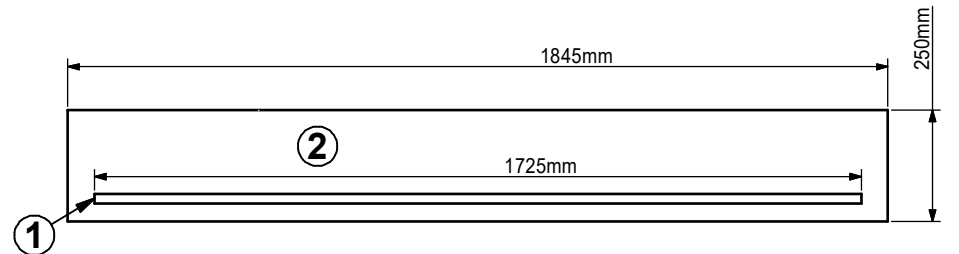
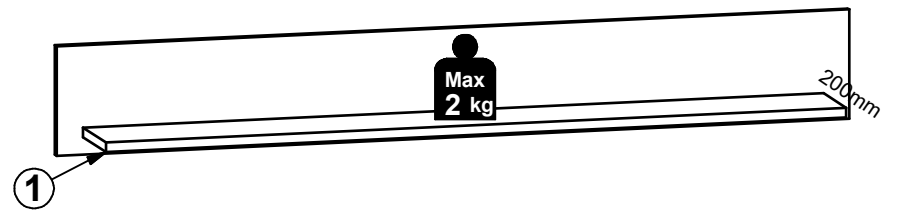
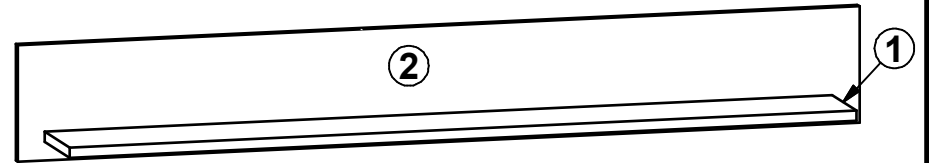
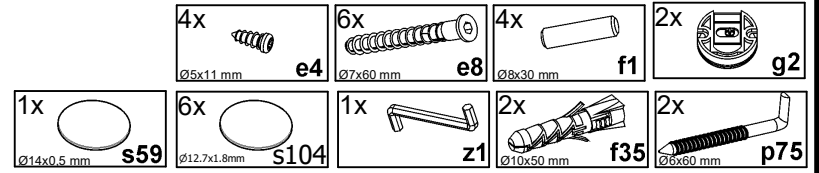

1

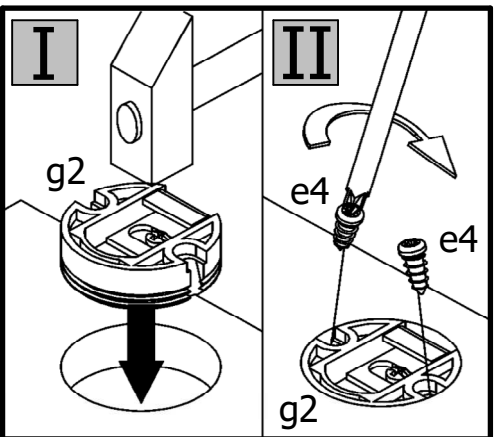

2x

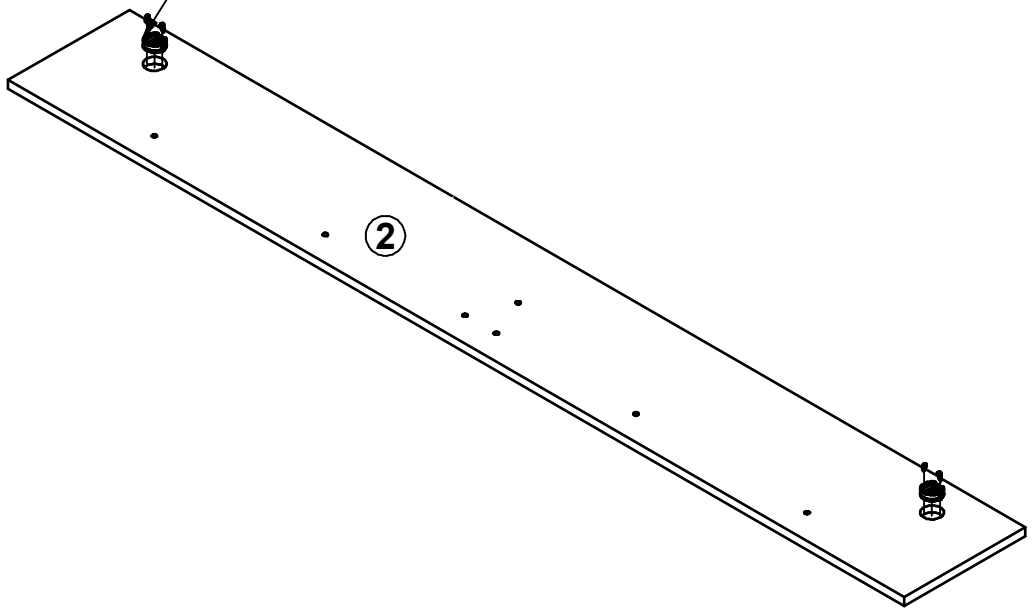
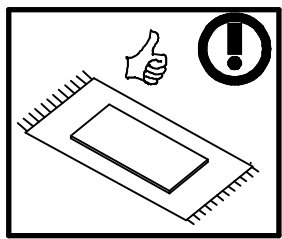

2

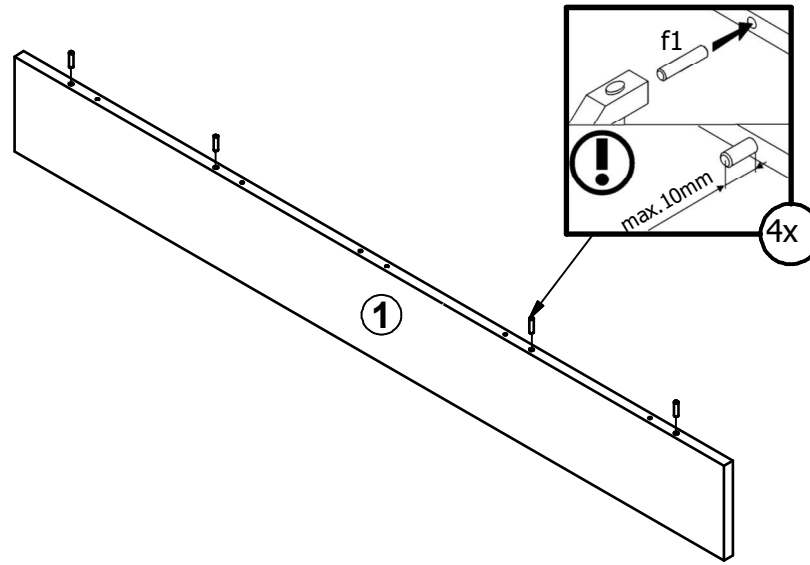

3

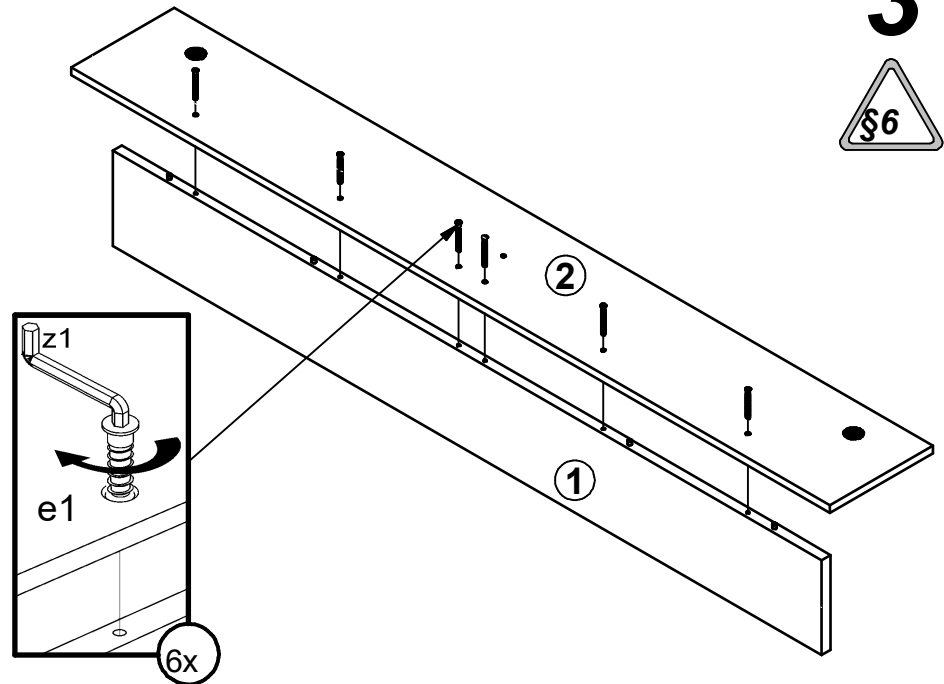

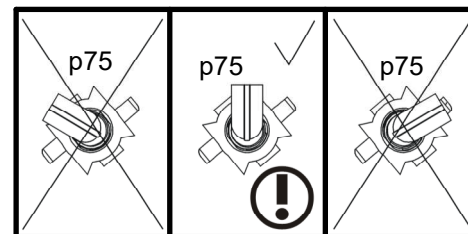
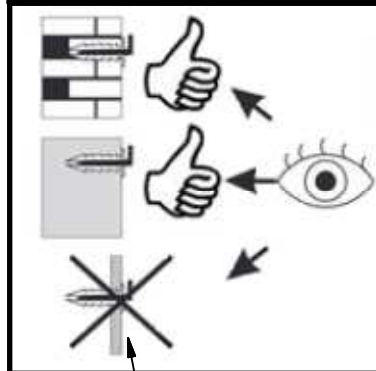
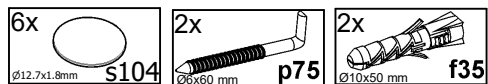
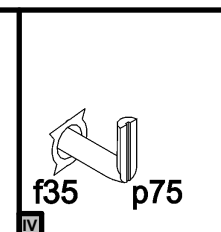
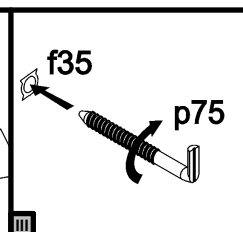
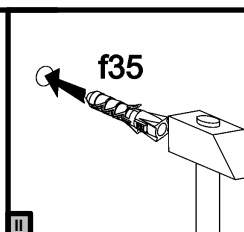
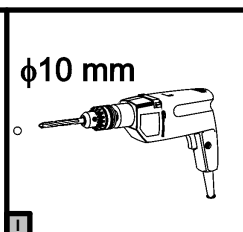
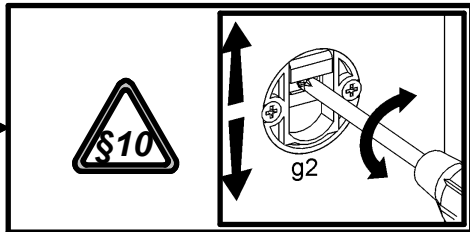
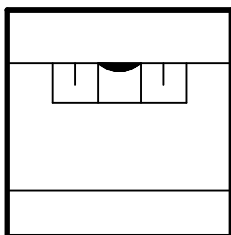

4

