

A F39-MATCH2 270 M

58-7L7

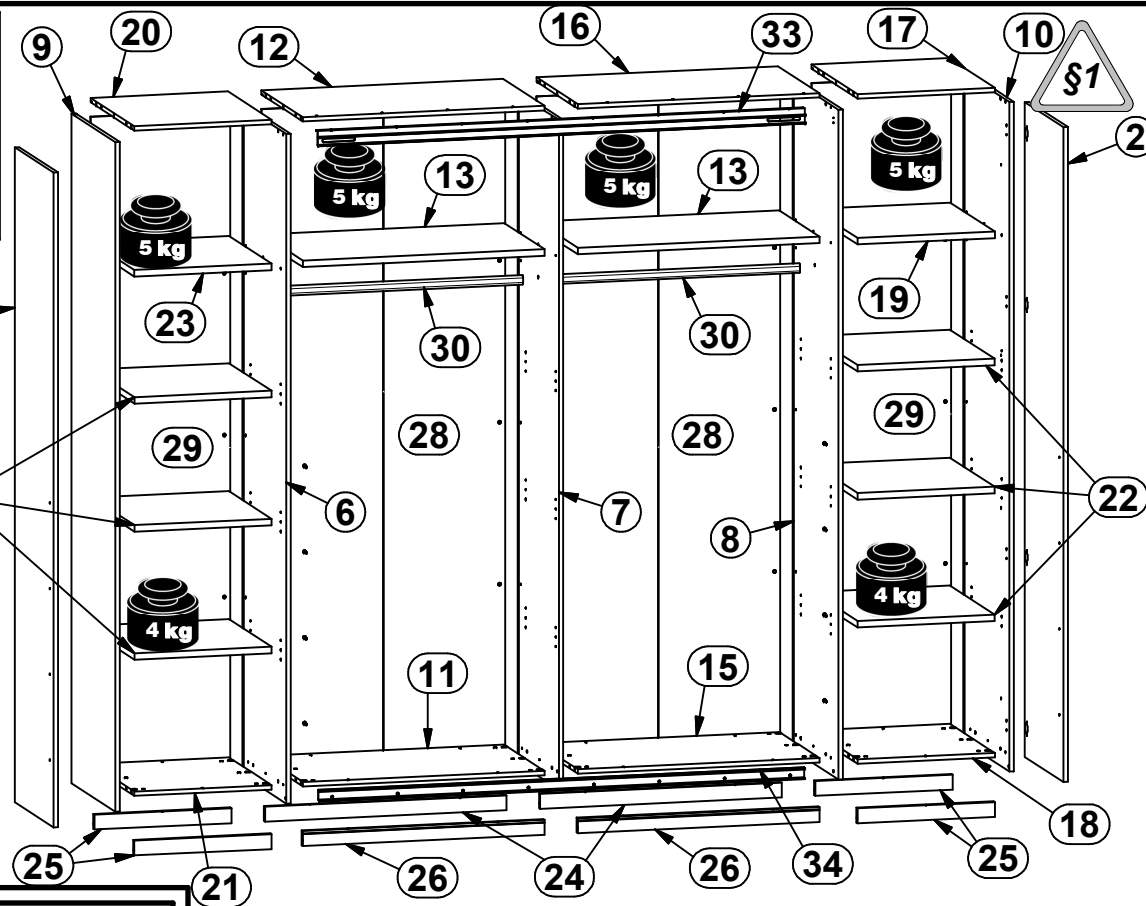

A	B	C (mm)		D
1	F39-001	2200	496	6/8
2	F39-002	2200	496	6/8
3	F39-006 A	850	550	7/8
4	F39-007	850	550	8/8
5	F39-008 A	850	550	7/8
6	F39-101 B	2250	560	1/8
7	F39-102 A	2249	530	3/8
8	F39-103 B	2250	588	2/8
9	F39-104	2250	560	1/8
10	F39-105	2250	588	2/8
11	F39-301	827	530	4/8
12	F39-302 A	827	530	4/8
13	F39-303	827	514	4/8
14	F39-305	469	543	3/8
15	F39-306	827	530	4/8
16	F39-307 A	827	530	1/8
17	F39-309	470	588	2/8
18	F39-310	470	588	2/8
19	F39-311	470	572	3/8
20	F39-321	470	560	1/8
21	F39-322	470	560	1/8
22	F39-323	469	571	3/8
23	F39-324	470	544	3/8
24	F39-401	827	50	2/8
25	F39-402	470	50	2/8
26	F39-403 A	827	50	2/8
28	F39-901	2177	835	2/8
29	F39-902	2178	478	1/8
30	dr-821x30	821	30	2/8
31	EG-sp 2200	2200	8	5/8
32	w118/7	2200	16	5/8
33	w249/4	1668	51	5/8
34	w250/6	1664	32	5/8
35	w172/1	2200	50	5/8
36	c410/2	900	17	2/8

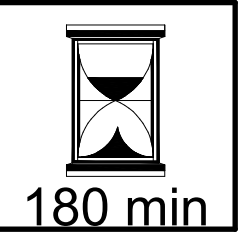
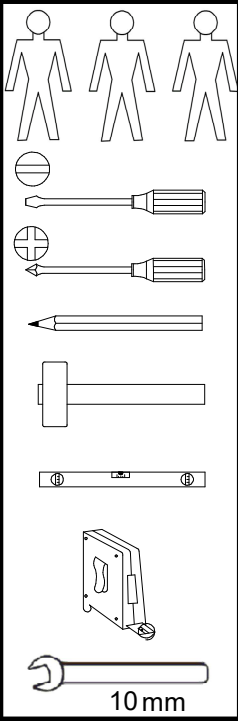



4x a83	4x hamulec a204	4x b32	4x b91
2x c410/2	24x d1	30x d20	24x d28
24x e5	12x e32	30x e50	24x e51
1x f73	1x f74	2x f75	2x f76
44x i2	2x n14/2	12x n148	4x n158
24x p51	96x p93	48x r37	48x r54

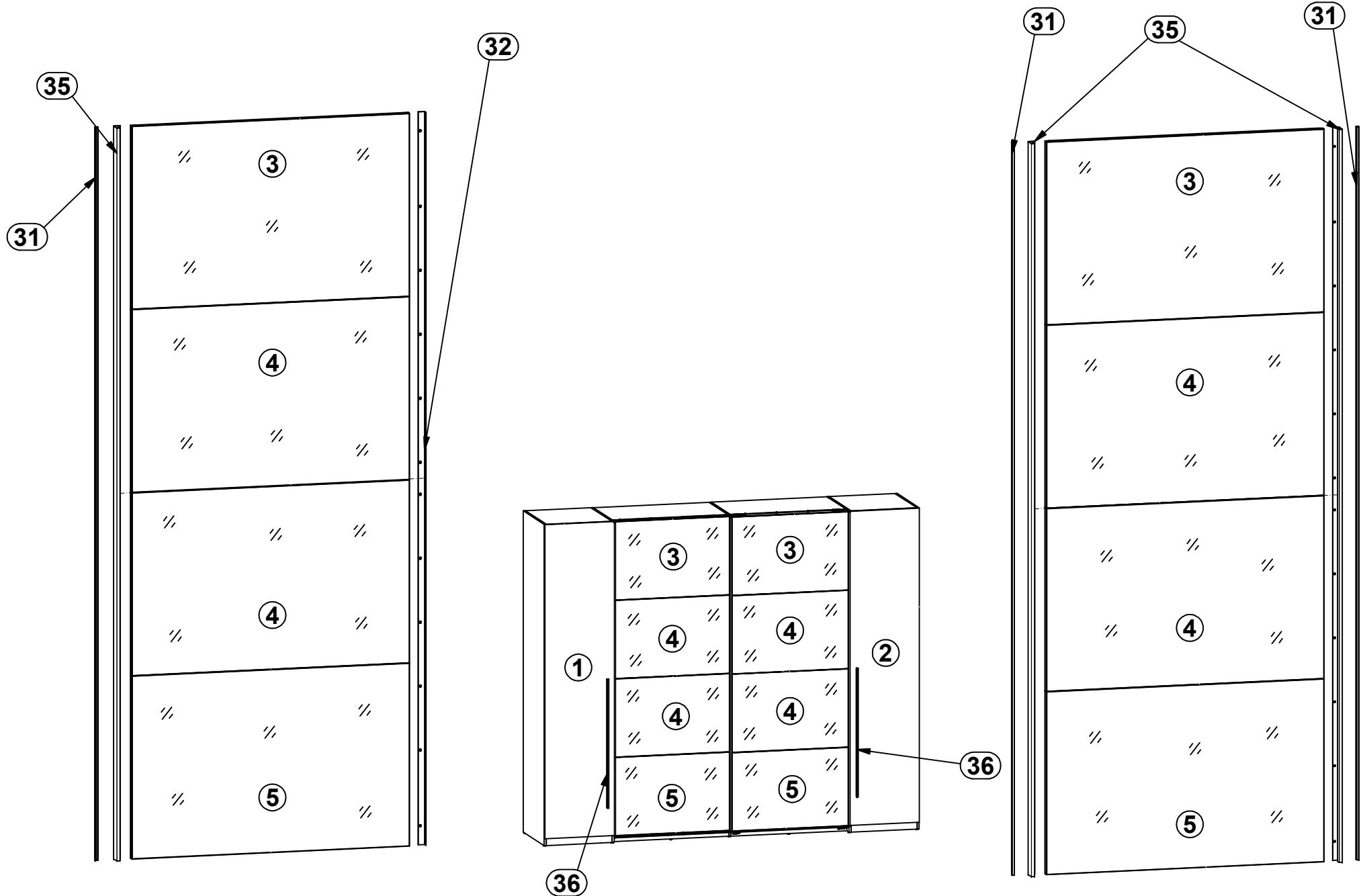

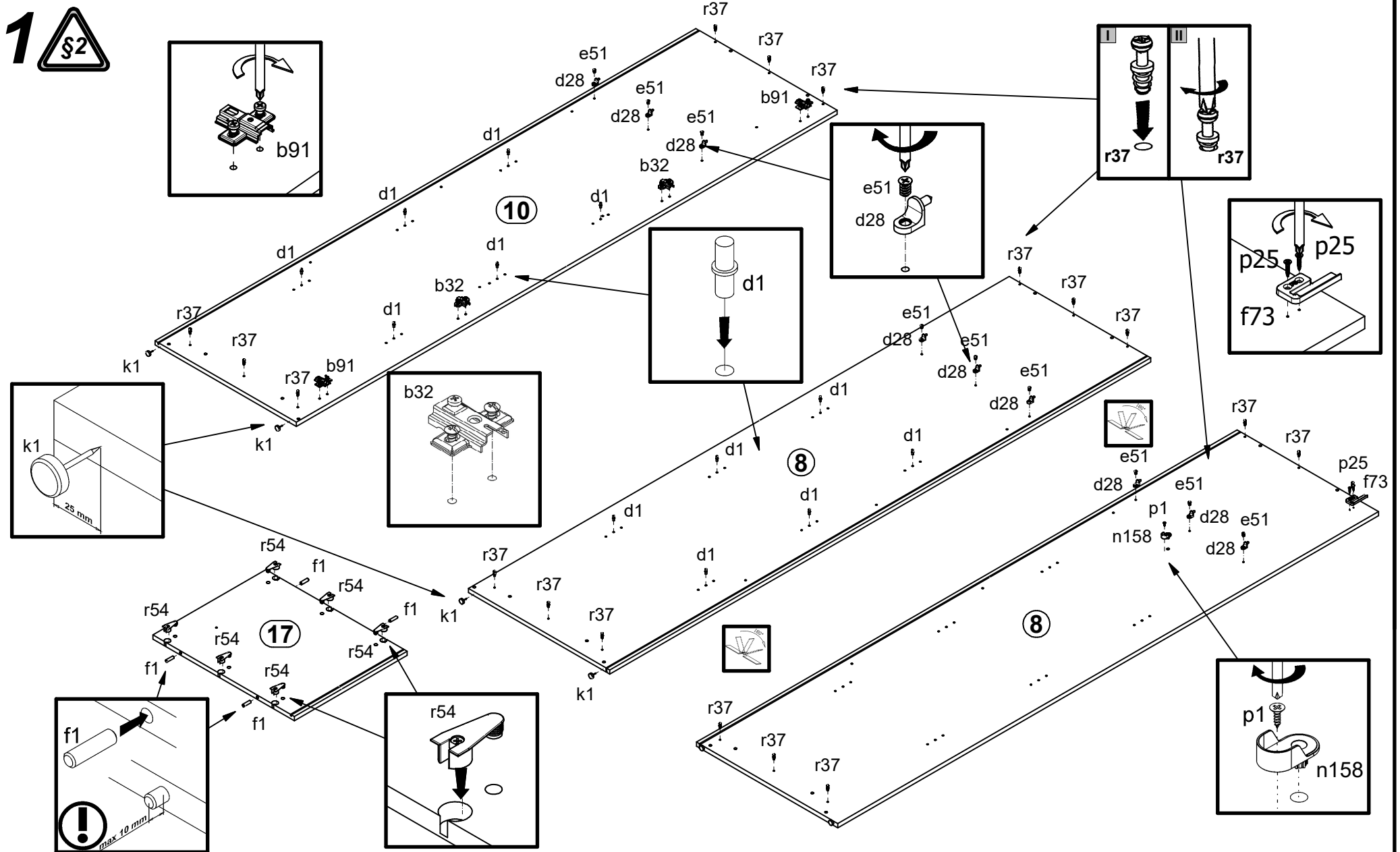
48x f1	2x f35	2x f69	2x f70	1x f71	1x f72
8x j84	8x j106	8x j140	2x j196	14x k1	
1x n238/2	1x n239/2	1x n240	1x n241/2	4x p1	8x p8
2x s113	1x w118/7	3x w172/1	1x w249/4	1x w250/6	1x z17

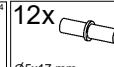
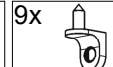
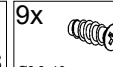
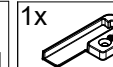
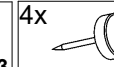

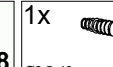
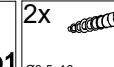





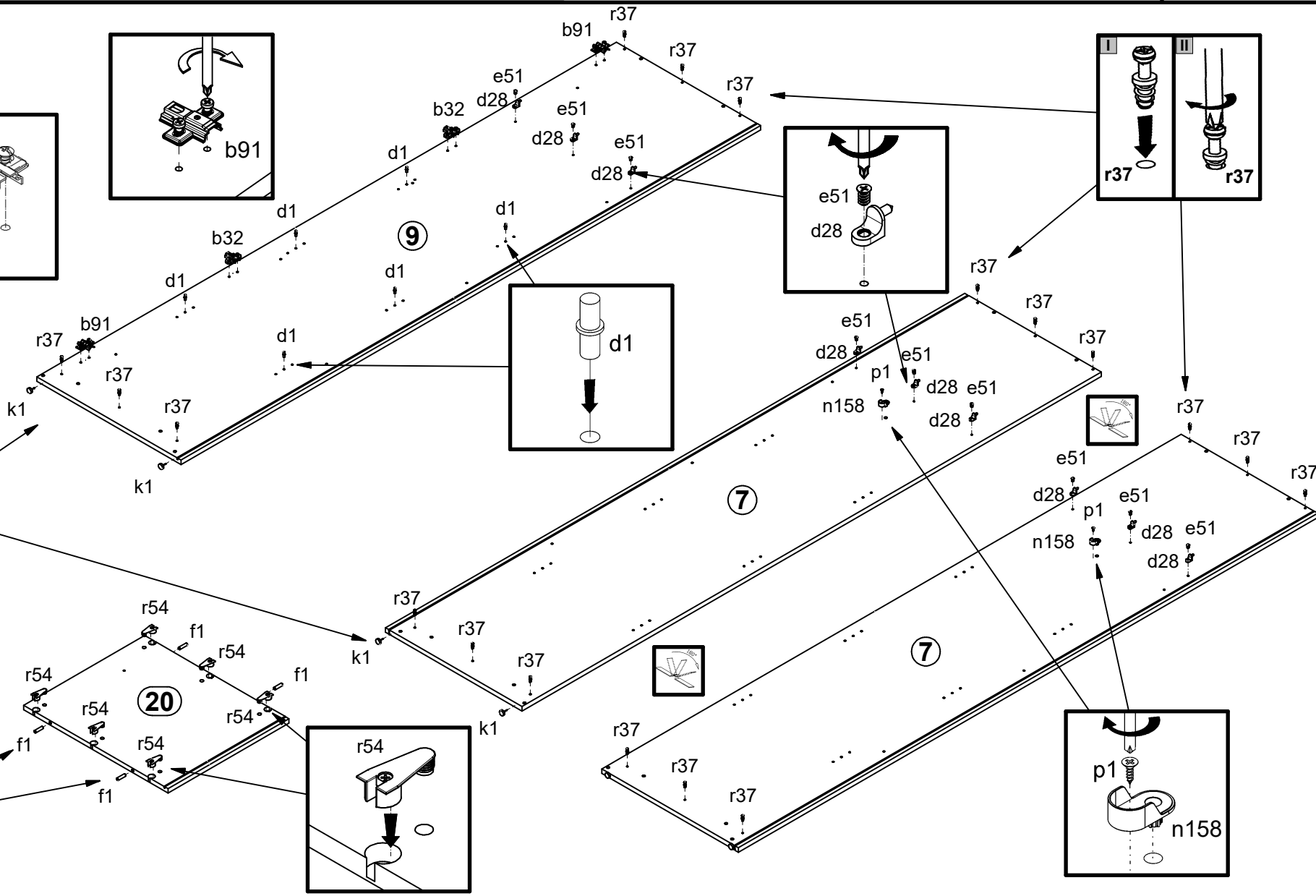
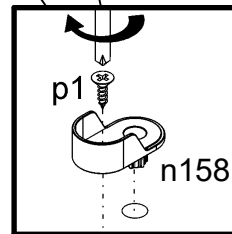
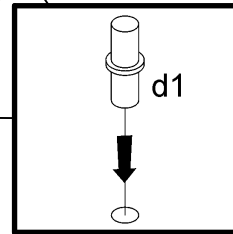
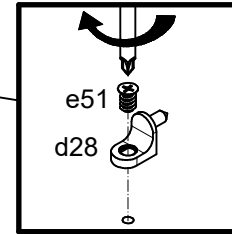
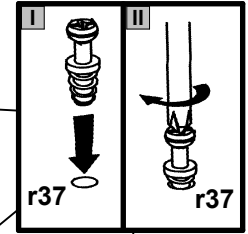
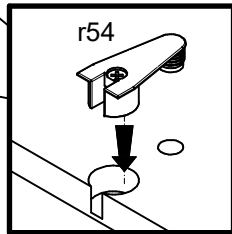
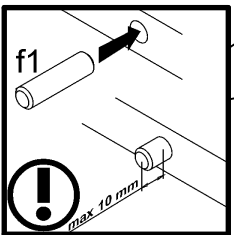
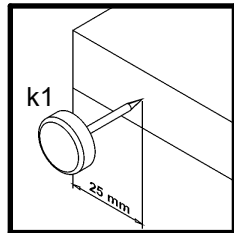
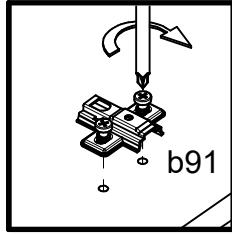
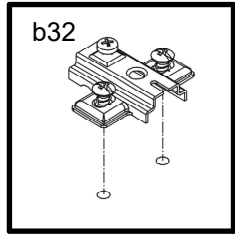





- 2x  **b32**
- 2x  **b91**
- 12x  **d1**
Ø5x17 mm
- 9x  **d28**
- 9x  **e51**
Ø6.3x10 mm
- 4x  **f1**
Ø8x30 mm
- 1x  **f73**
- 4x  **k1**
- 1x  **n158**
- 1x  **p1**
Ø3.5x13 mm
- 2x  **p25**
Ø3.5x16 mm
- 18x  **r37**
6.7/7.8
- 6x  **r54**
Ø20x13.5 mm #19









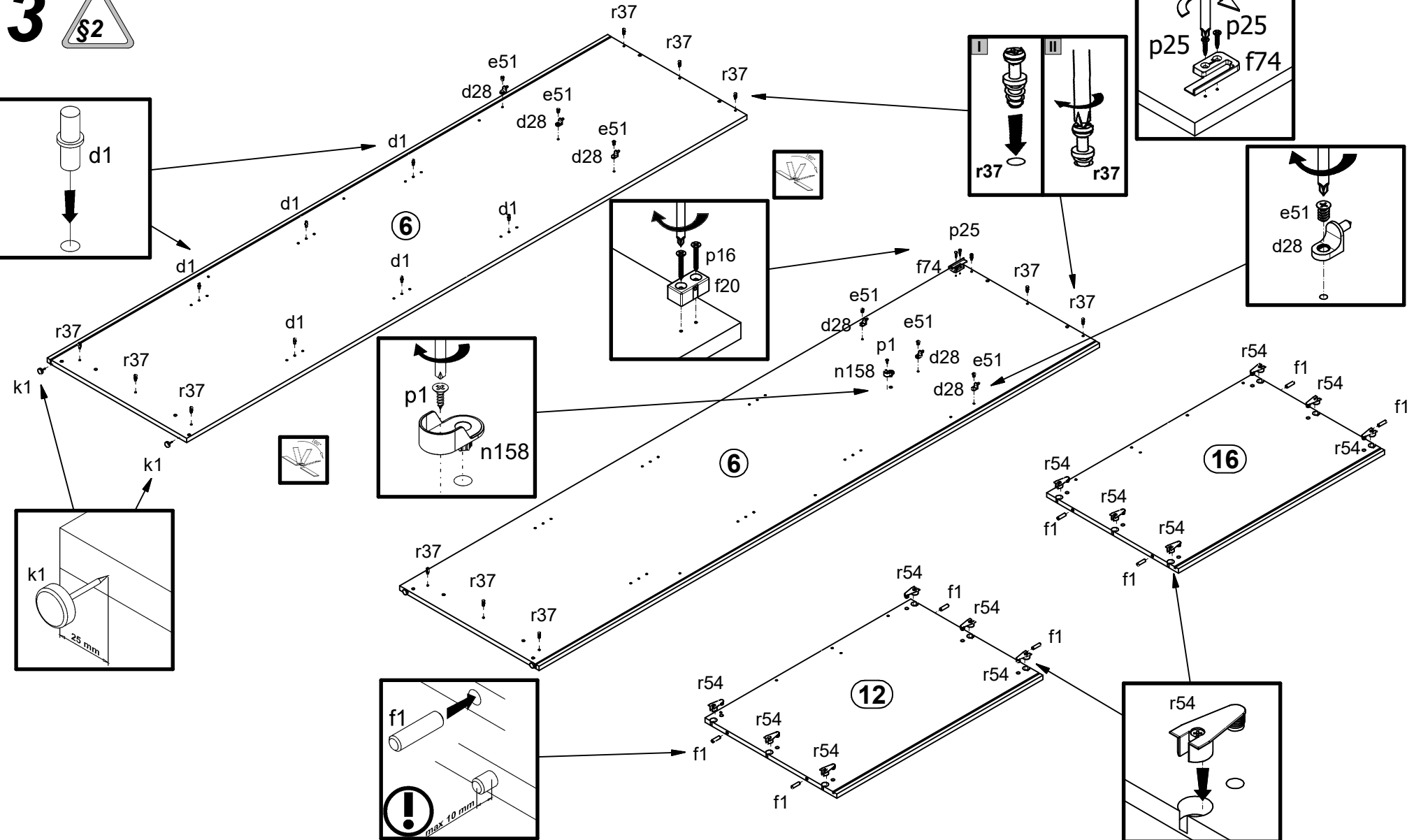
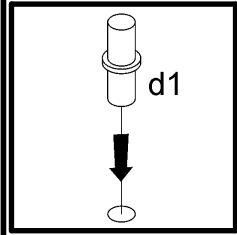

2 



- 2x  b32
- 2x  b91
- 6x  d1
Ø5x17 mm
- 9x  d28
- 9x  e51
Ø6,3x10 mm
- 4x  f1
Ø8x30 mm
- 4x  k1
- 2x  n158
- 2x  p1
Ø3,5x13 mm
- 18x  r37
6,7/7,8
- 6x  r54
Ø20x13,5 mm #19

3 



- | | | | | | | | | | | |
|---|---|---|---|---|---|---|---|---|---|---|
| 
6x
∅5x17 mm | 
6x
∅6,3x10 mm | 
6x
∅6,3x10 mm | 
8x
∅8x30 mm | 
1x | 
2x | 
1x | 
1x
∅3,5x13 mm | 
2x
∅3,5x16 mm | 
12x
6,7/7,8 | 
12x
∅20x13,5 mm #19 |
|---|---|---|---|---|---|---|---|---|---|---|

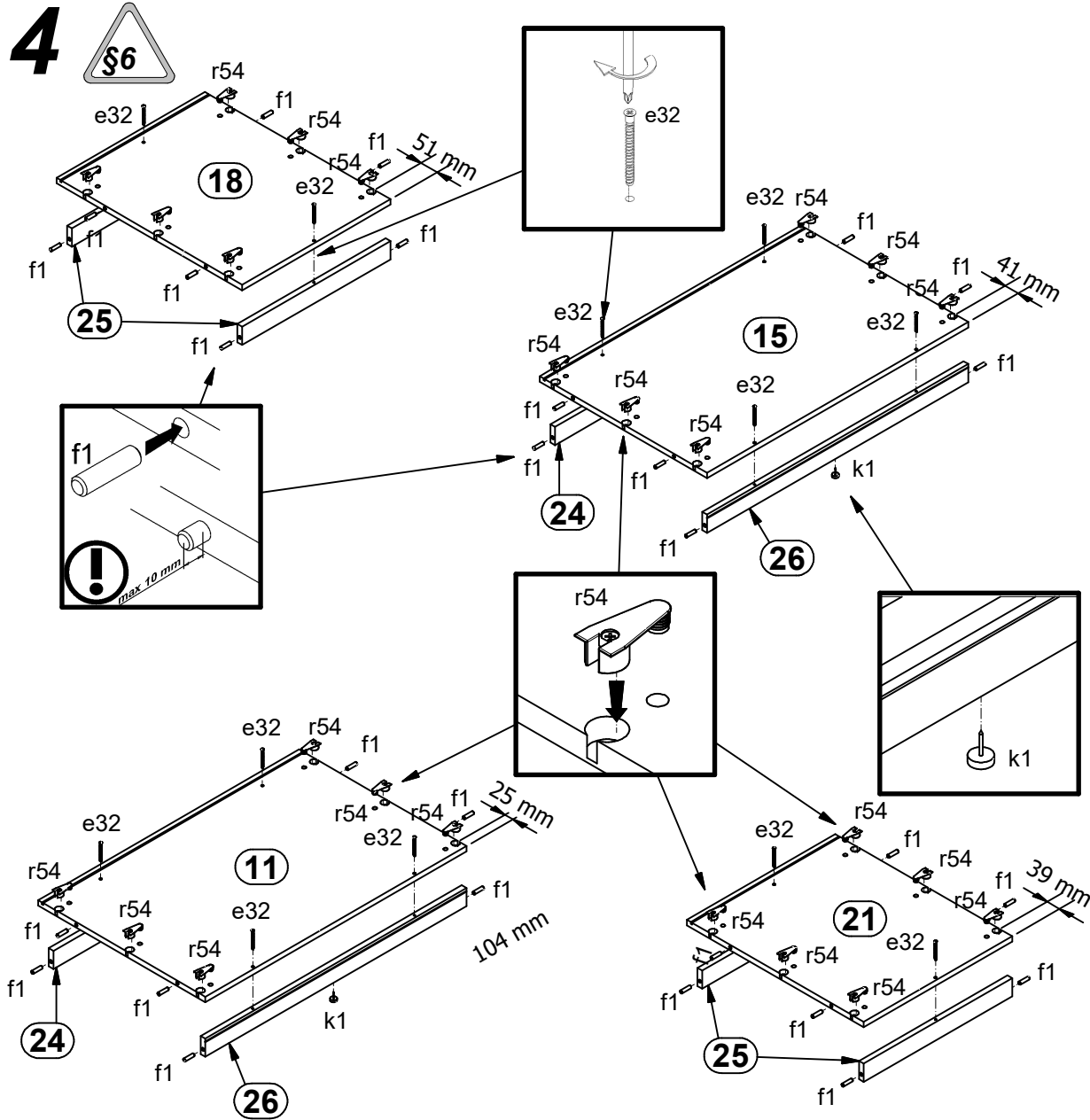

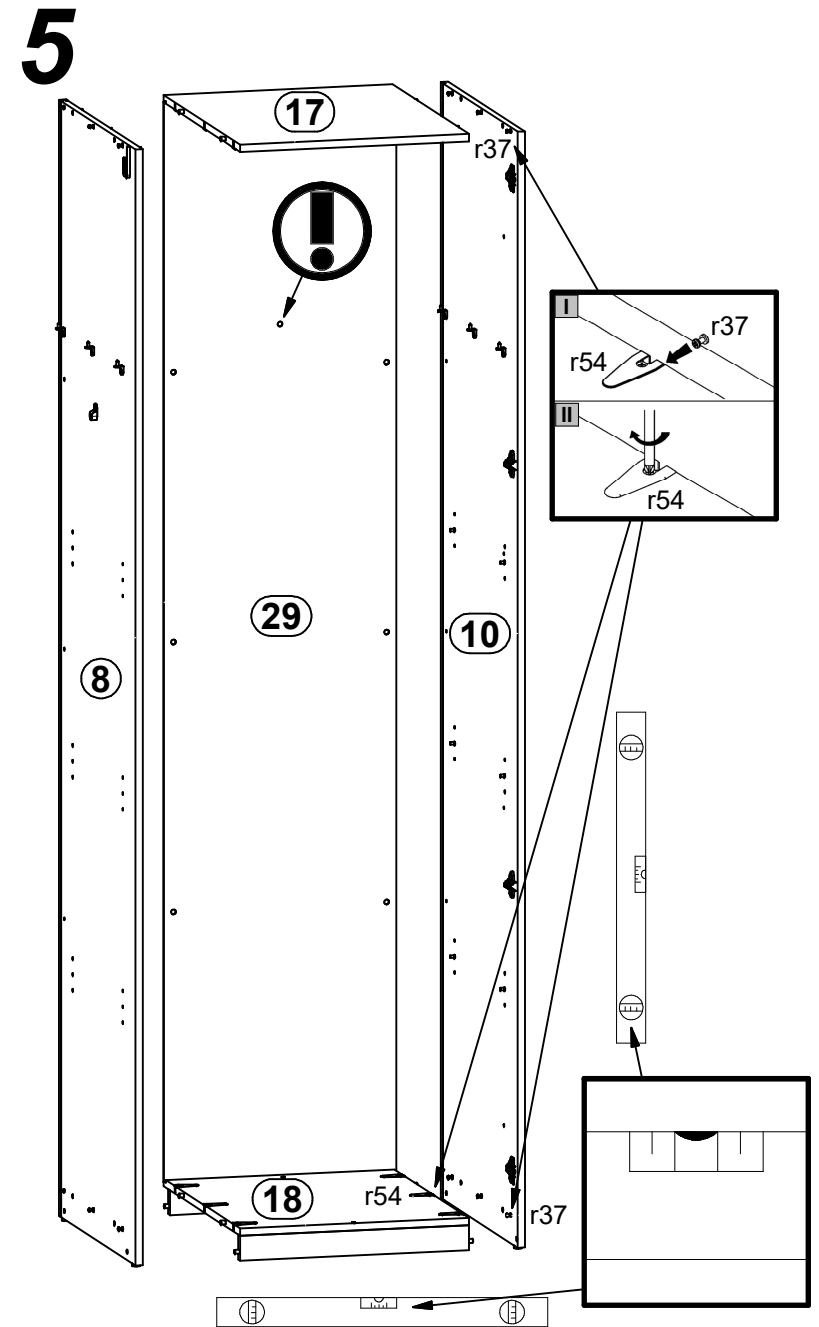

- | | | | |
|------------------------|-----------------------|----------|-------------------------------|
| 12x
Ø5x50 mm
e32 | 32x
Ø8x30 mm
f1 | 4x
k1 | 24x #19
Ø20x13.5 mm
r54 |
|------------------------|-----------------------|----------|-------------------------------|

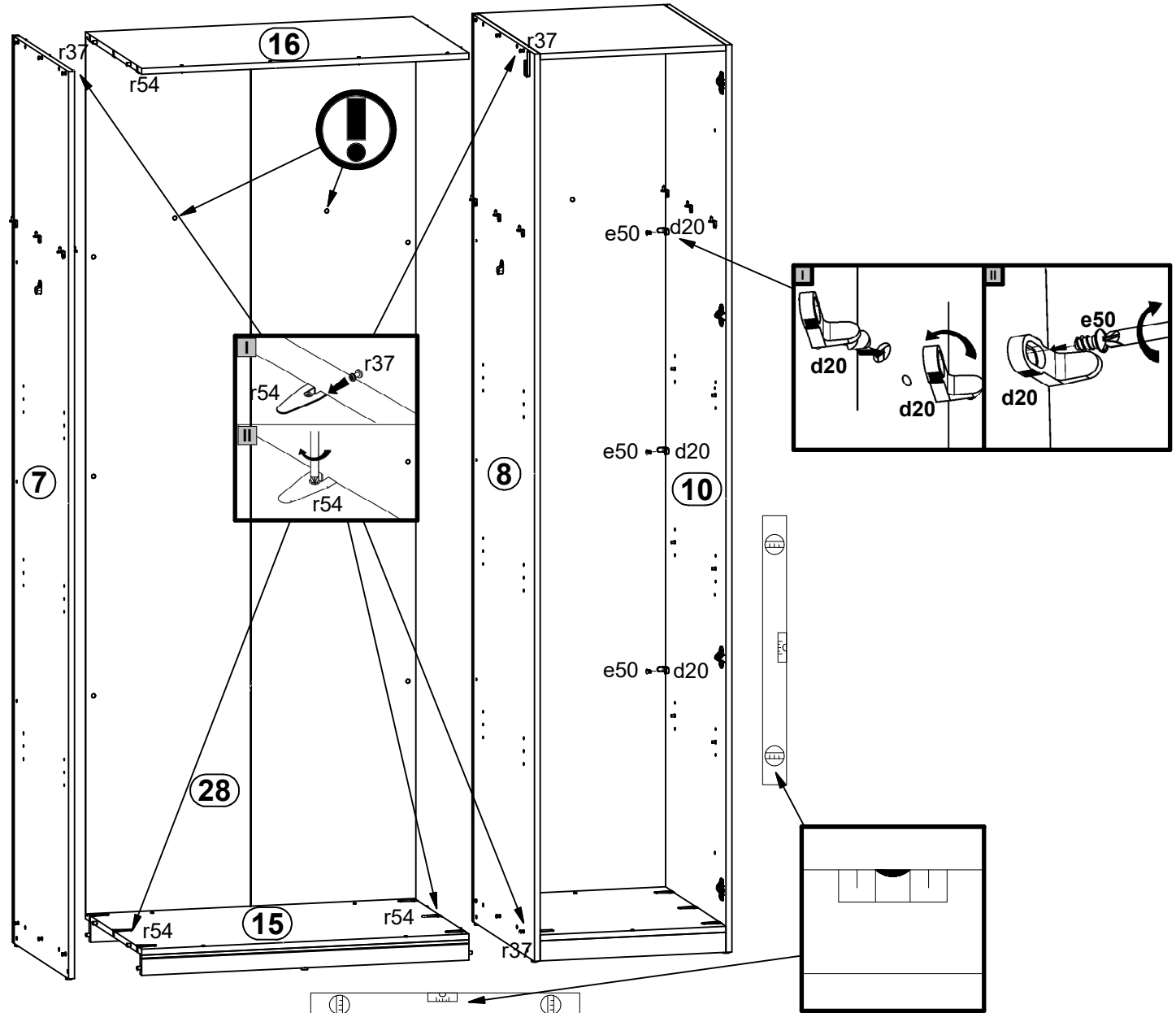

6 



- 6x  d20
- 6x  e50

7

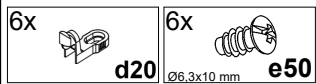
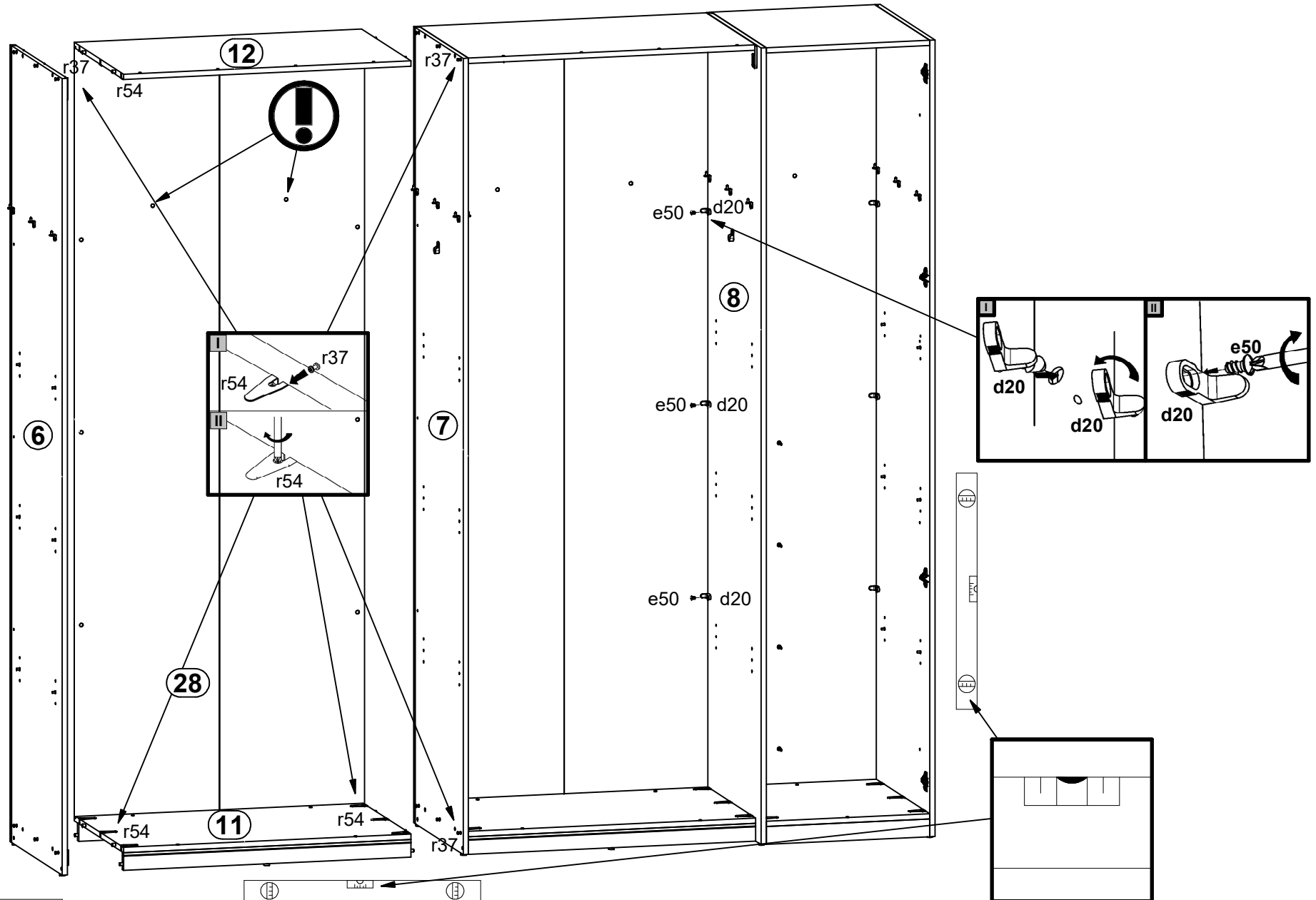

8 

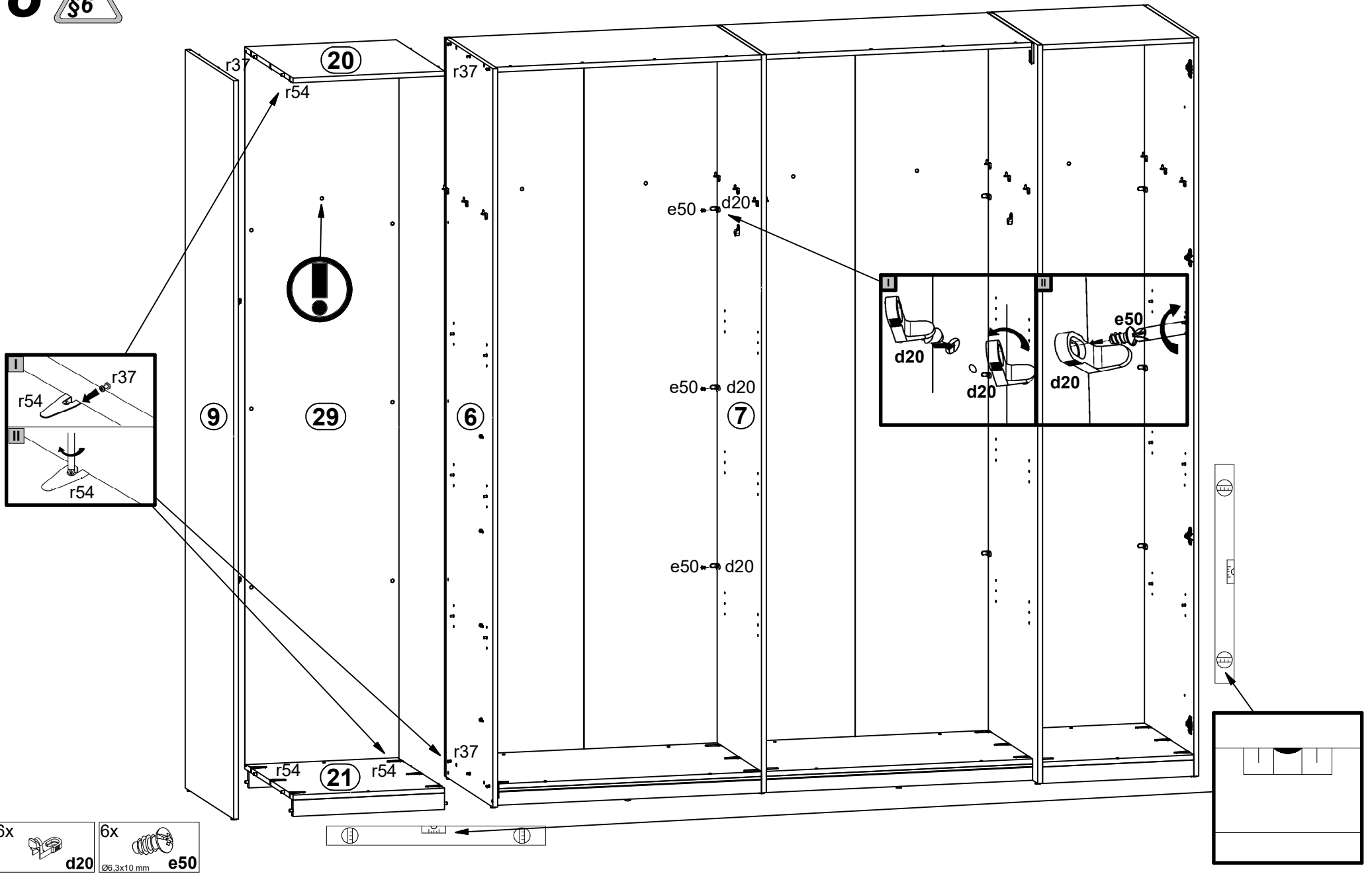

9

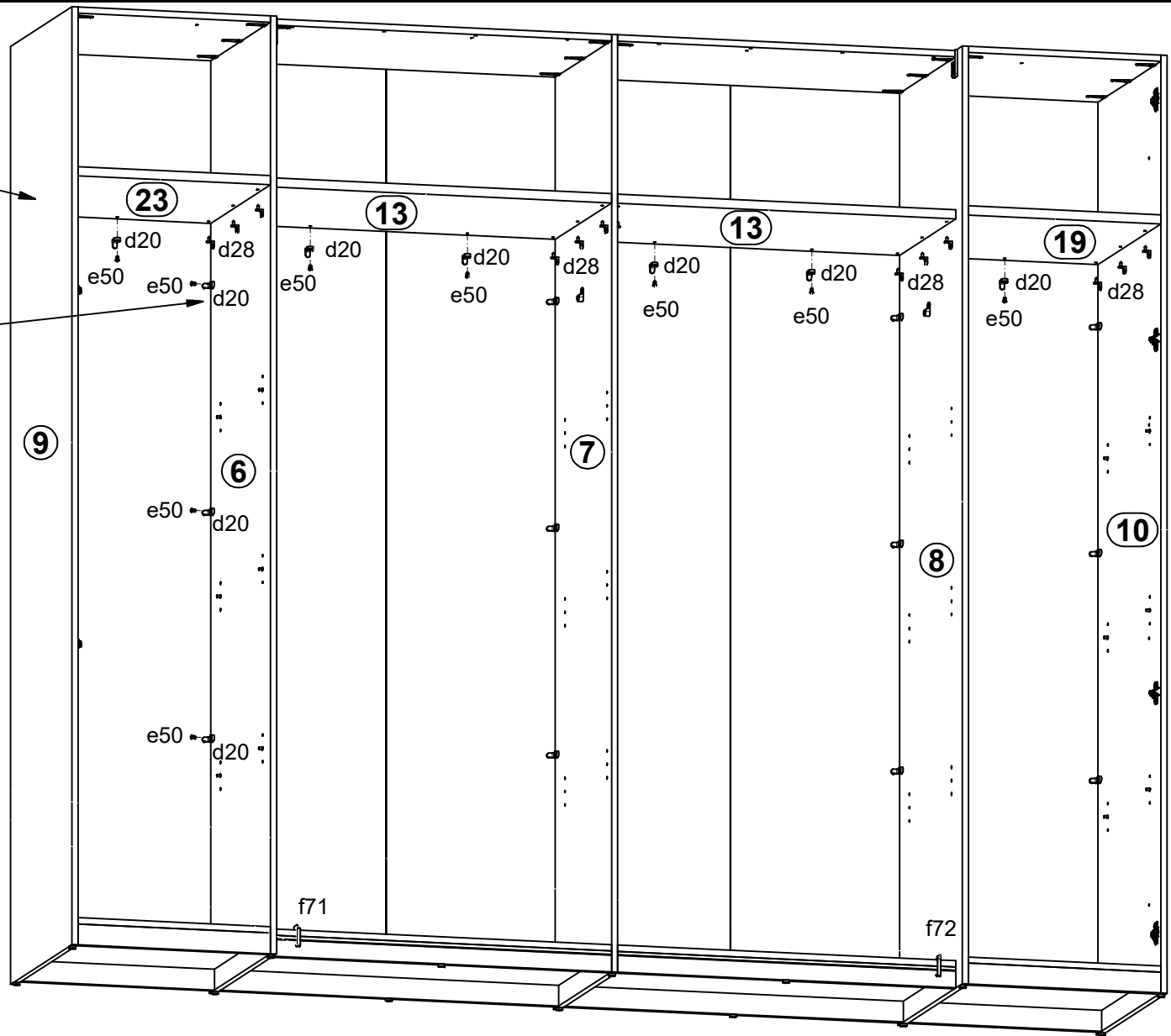
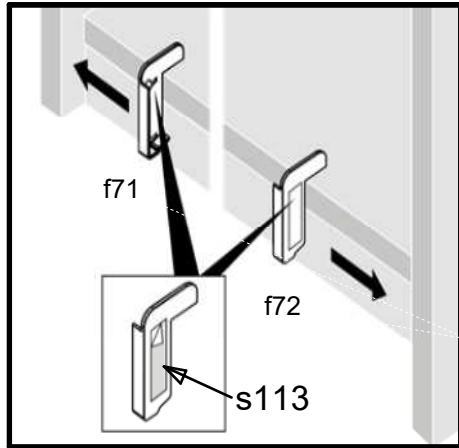
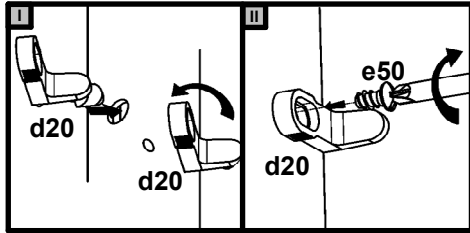
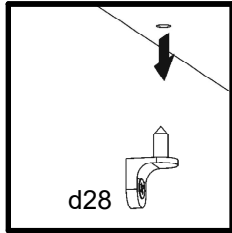

- 12x d20
- 12x e50
- 2x s113
- 1x f71
- 1x f72

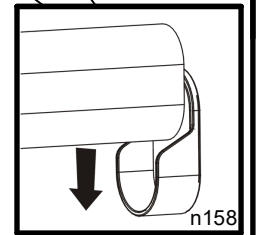
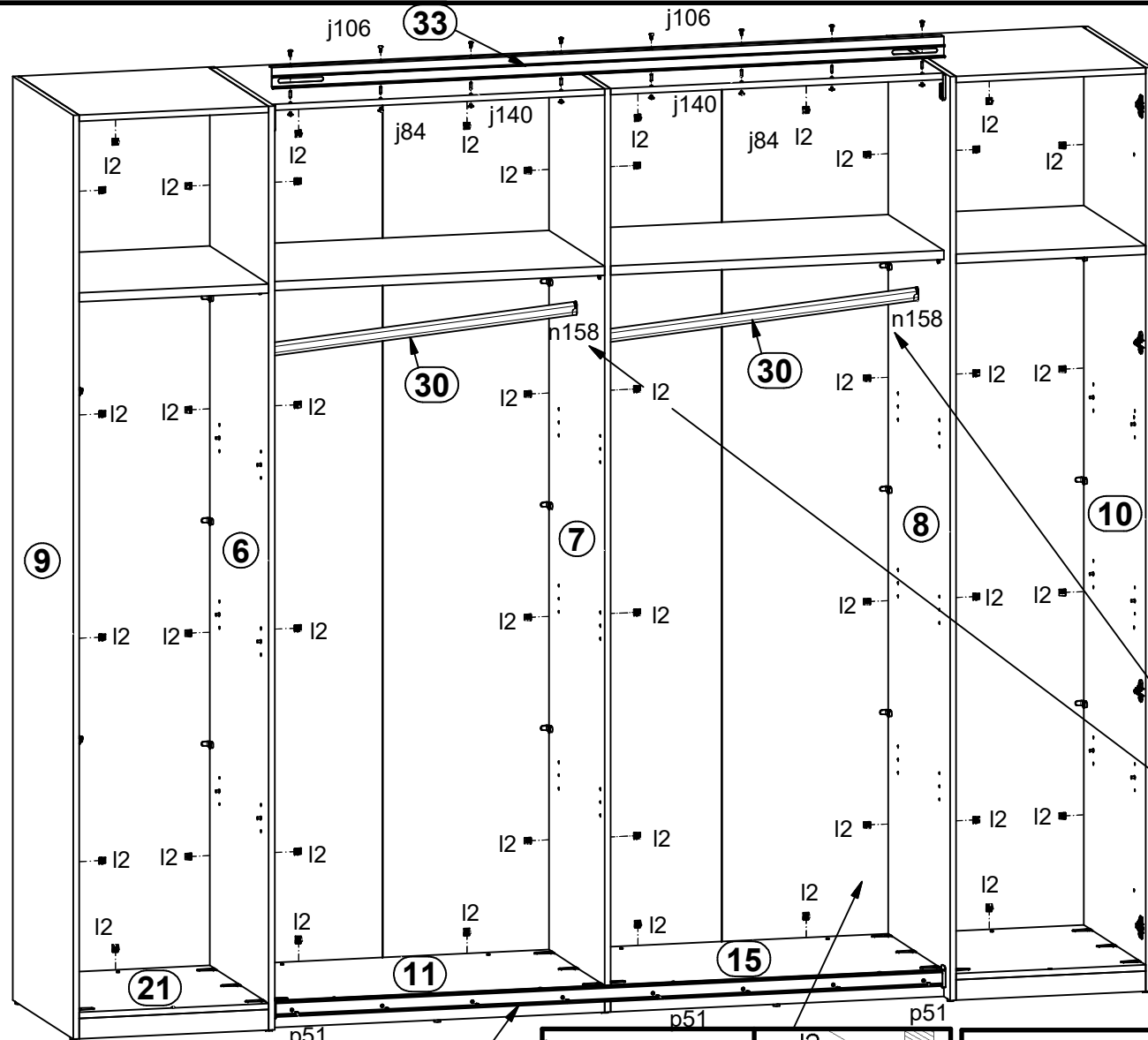
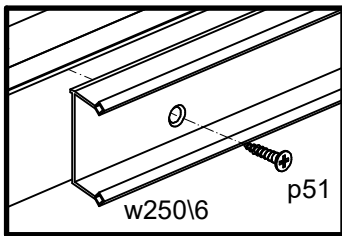
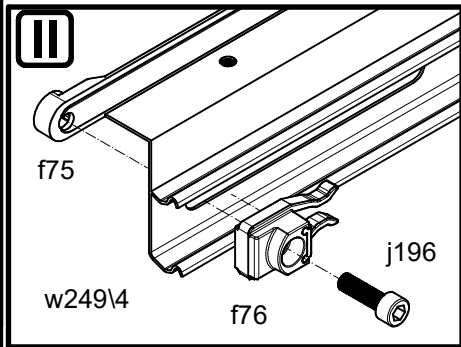
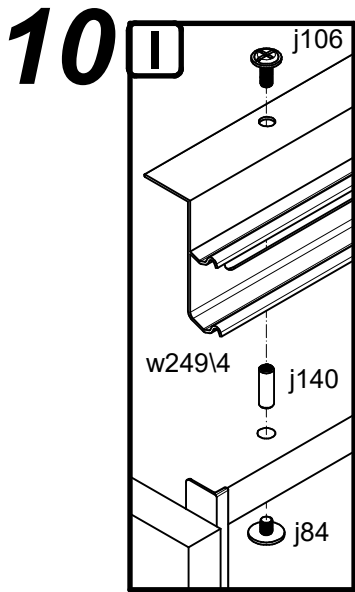

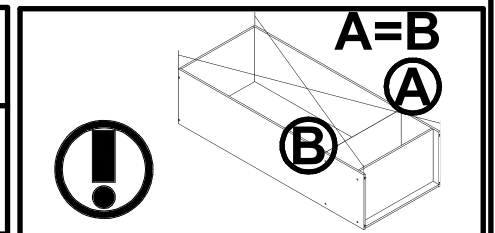
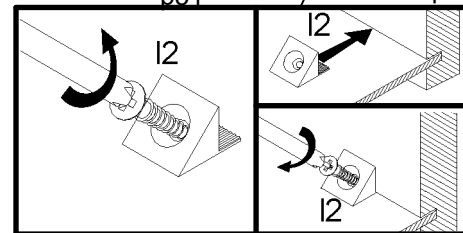

- | | | | |
|------------|---------------------|------------|-----------------------|
| 2x
f55 | 8x
M4x10 mm j106 | 8x
j140 | 1x
L-1664mm w250\6 |
| 2x
j196 | 8x
M4x5 mm j84 | 44x
I2 | 1x
L-1668mm w249\4 |
| | | | 8x
Ø3.5x15 mm p51 |



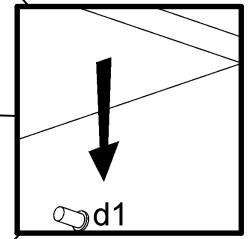
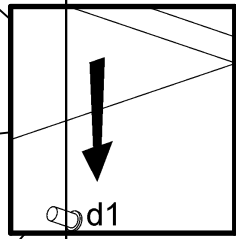
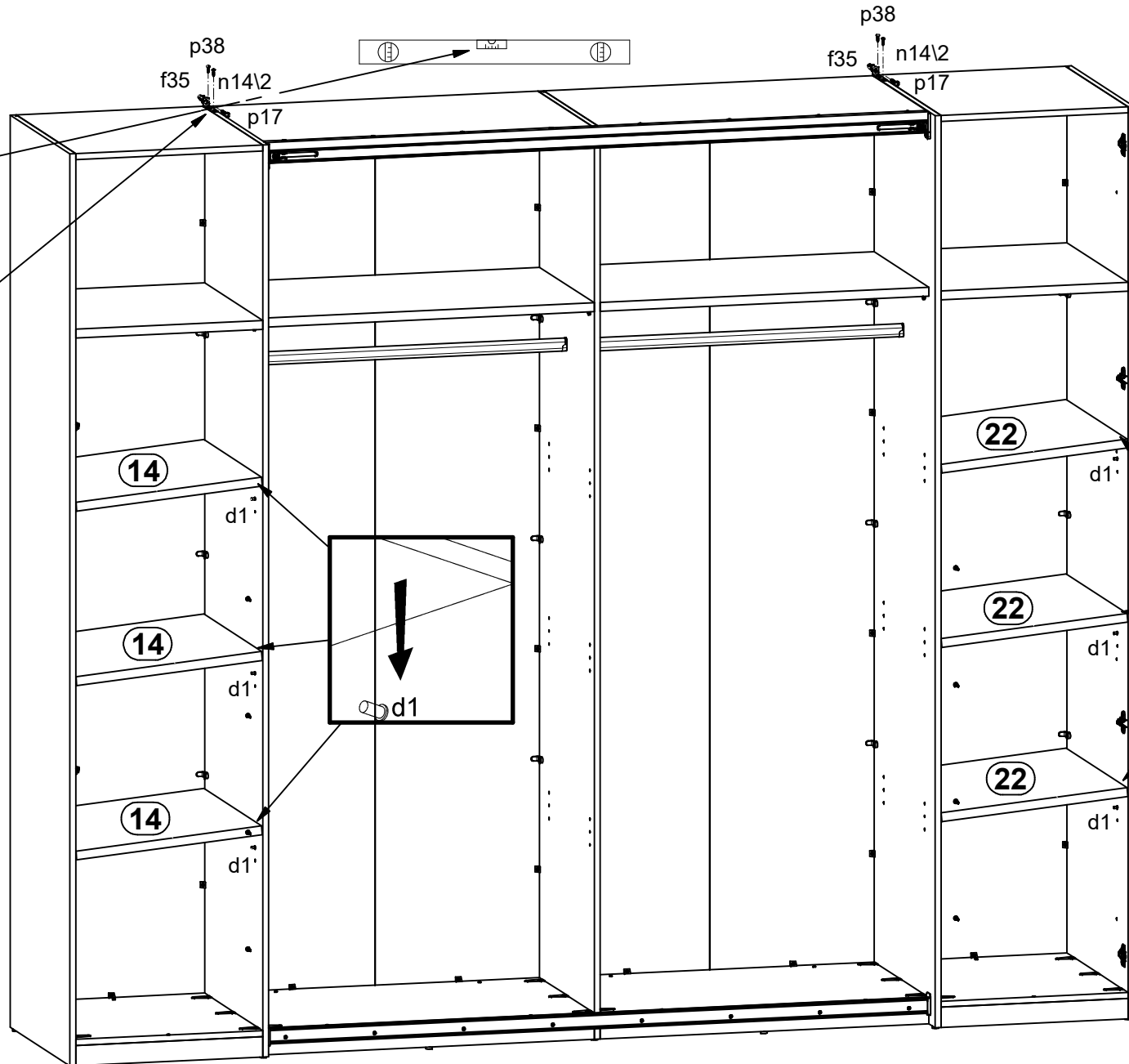
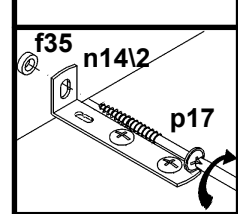
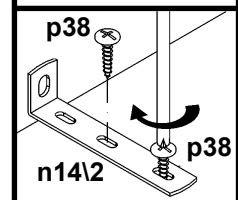
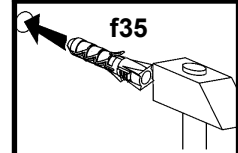
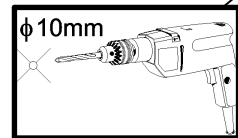
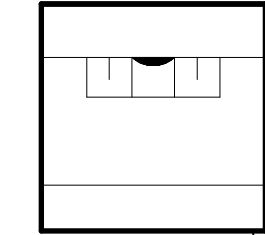

11 

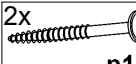
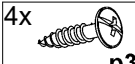

- 2x  f35
- 2x  n14\2
- 2x  p17
- 4x  p38

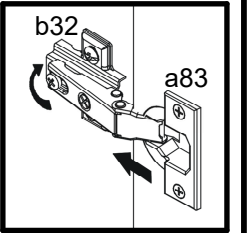
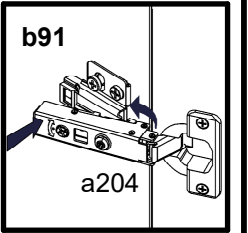
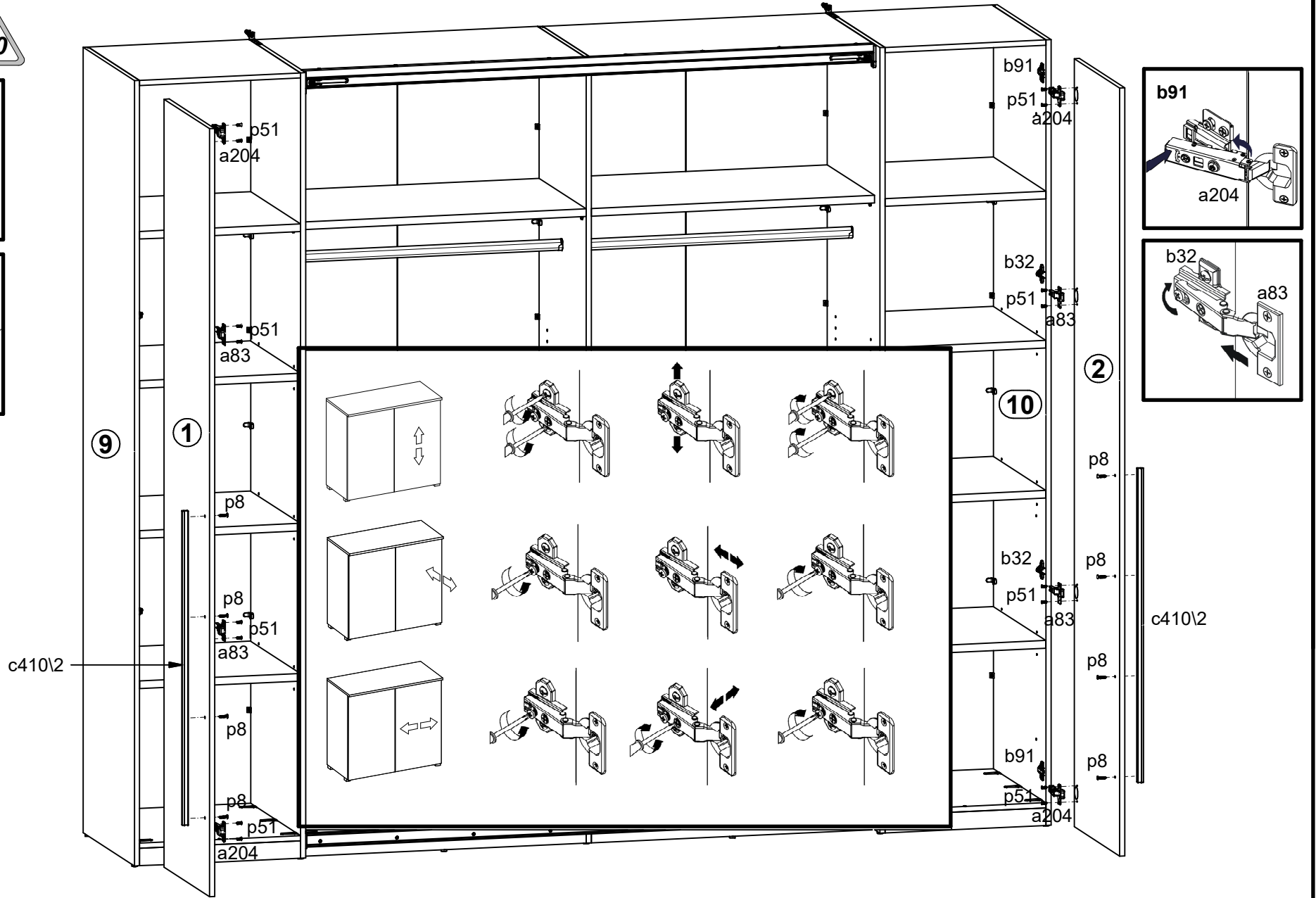
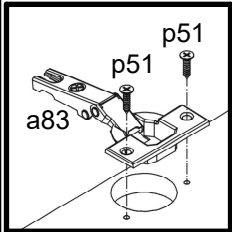
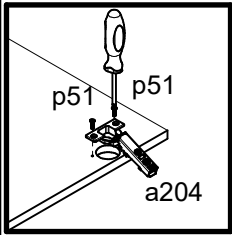
12 

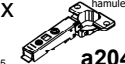
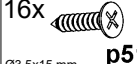

- 4x  **a83**
- 4x  **a204**
- 2x  **c410\2**
- 8x  **p8**
- 16x  **p51**

14

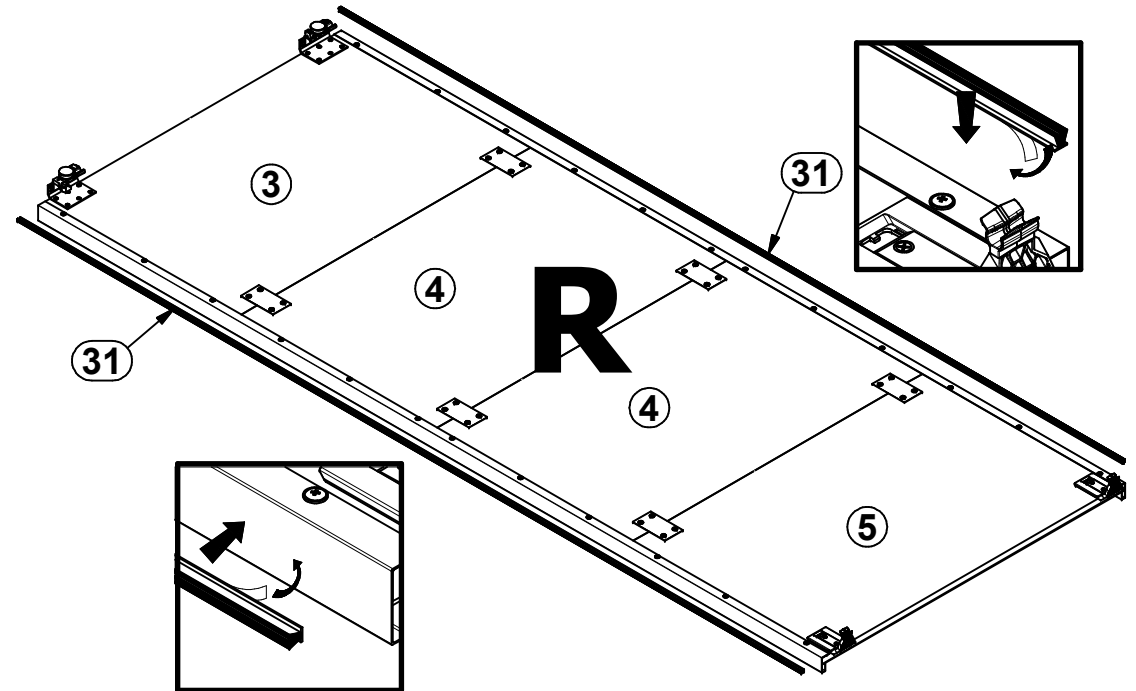
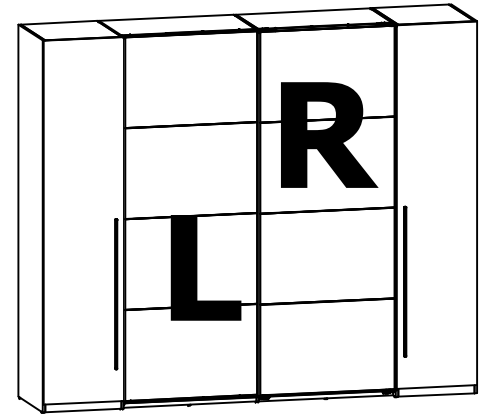
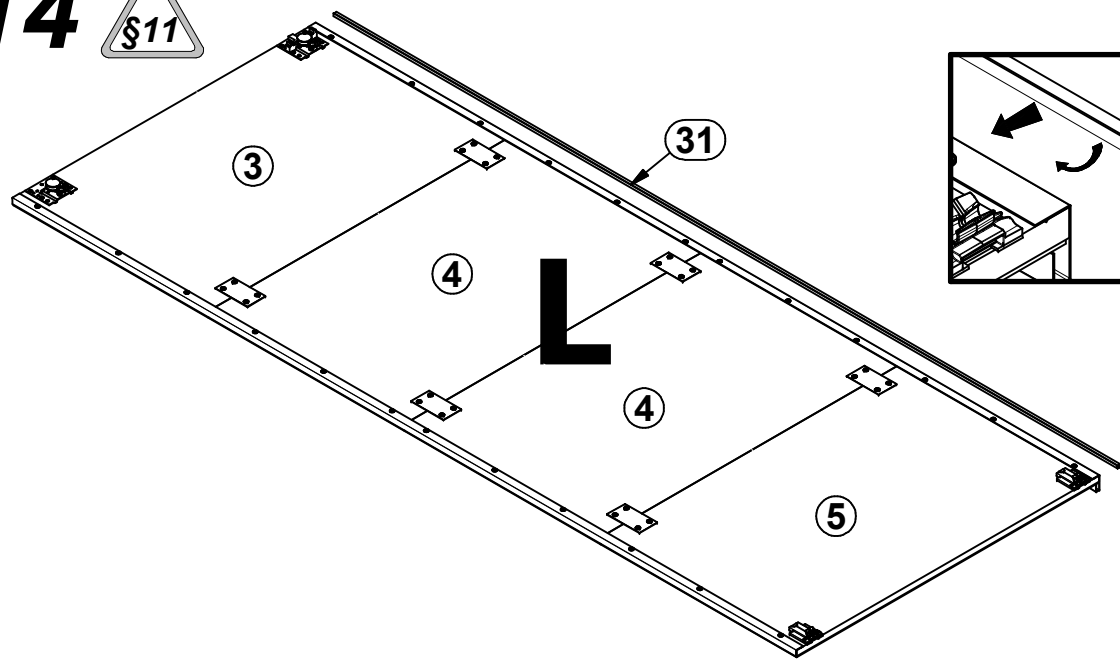

15

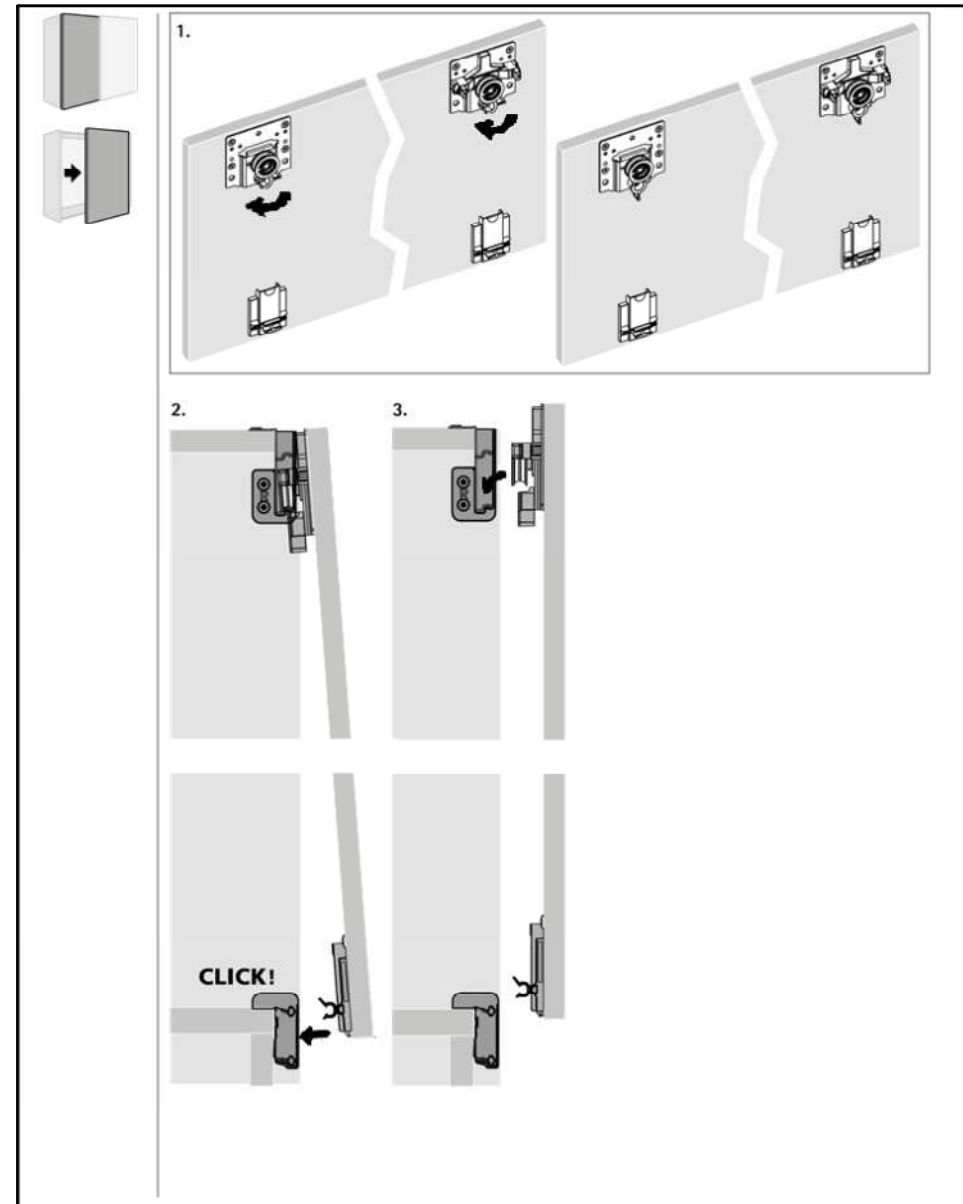
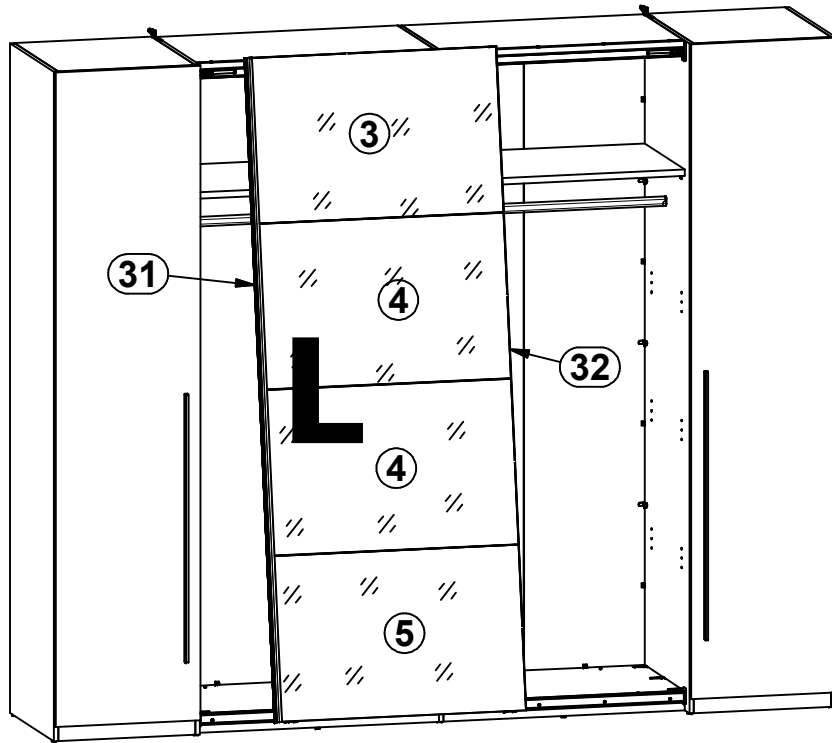

16

