

980443

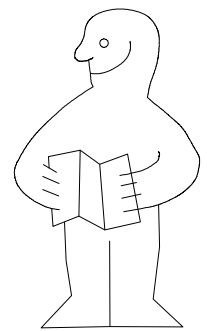

1-2-3-4...

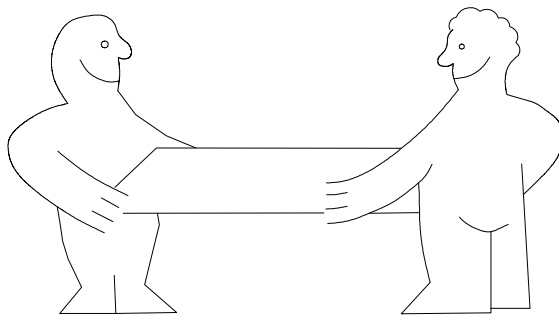
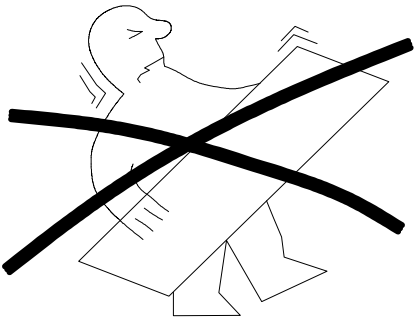
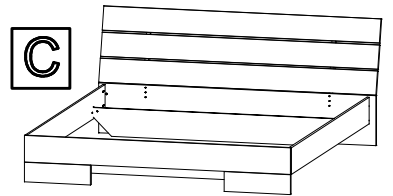
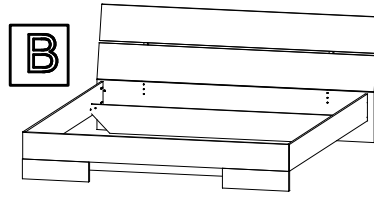
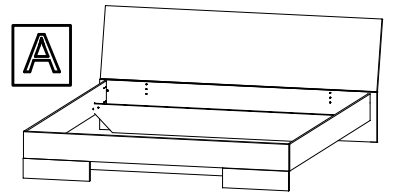
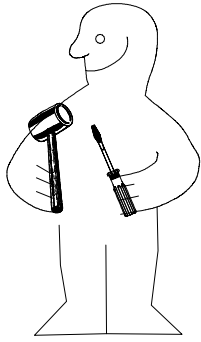
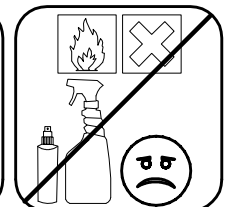
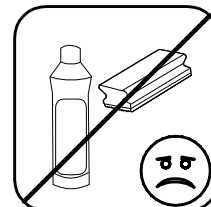
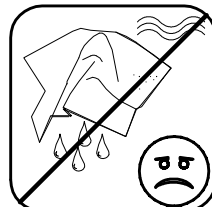
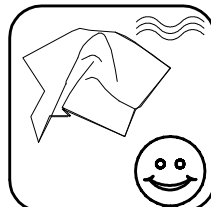
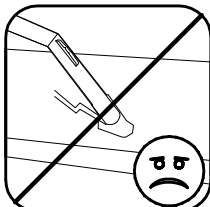
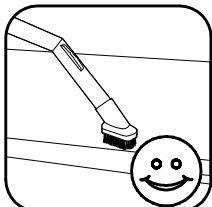
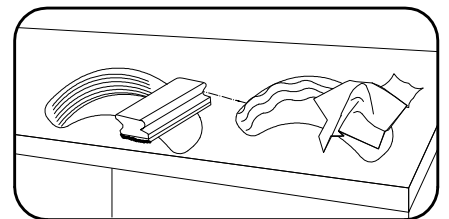
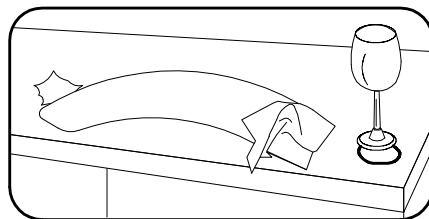
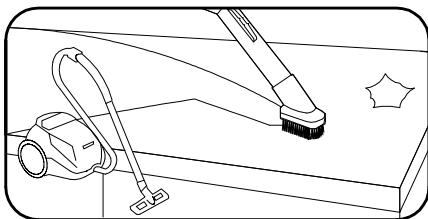
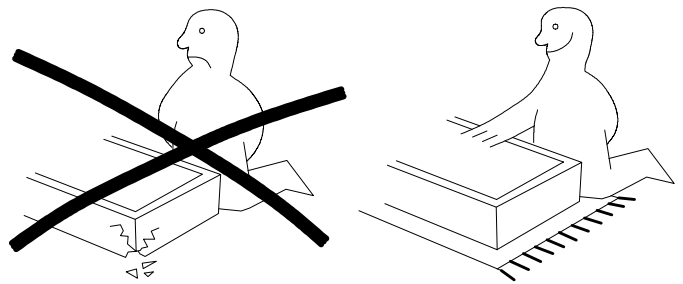
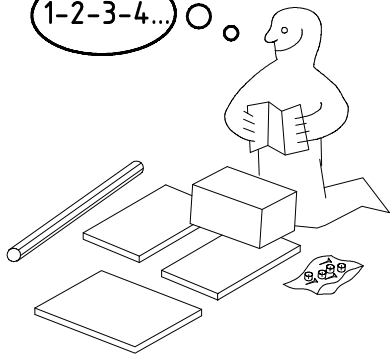

6,0 x 12 mm G4
121 148
9x

5,0 x 25 mm G5
121 156
4x

o16
111 004
2x

G6
121 150
4x

M6 x 11 mm T5
121 180
12x

4 X 20mm SP20
121 121
8x

o5
111133
4x

o3
111 353
1x

o
111 131
4x

4,0 x 15 mm G23
121 110
28x

φ 10 x 13 mm H
111 112
9x

4 X 27mm SP27
122620
13x 19x

A **BC**
13x 19x

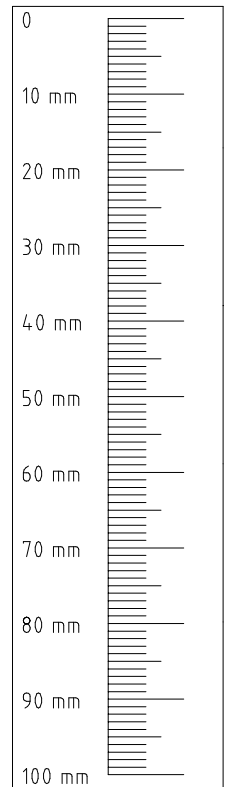
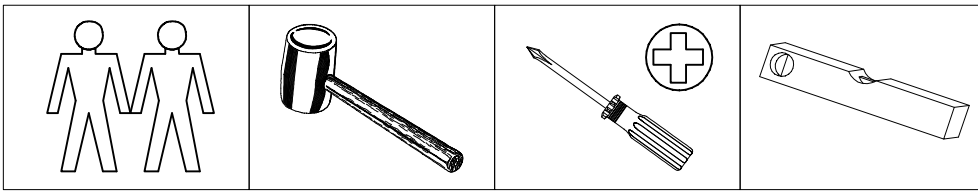

A

B

C

1x ①
1884/1684/1484/ x 480 x 15

2x ①
1884/1684/1484/ x 240 x 18

3x ①
1884/1684/1484/ x 160 x 18

③
1884/1684/1484 x 333 x 15

④
1836/ 1636/ 1436 x 180 x 18

⑤
2x 2000 x 180 x 18

⑥
2x 1800/ 1600/ 1400 x 200 x 15

⑨
480x85x15

⑦
2x 450 x 160 x 22

②
2x L600 (A)/ 2x L750 (B+C)

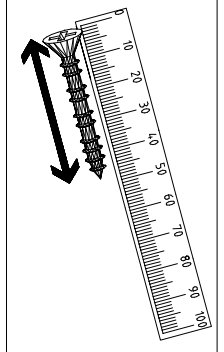

1

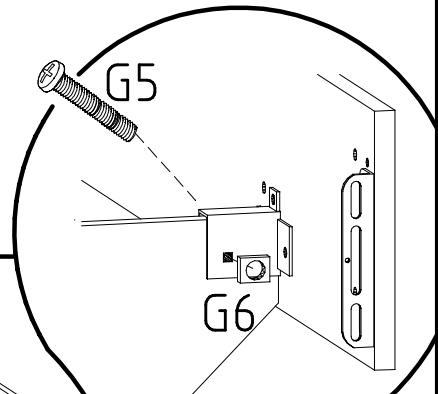
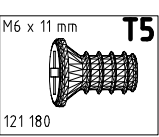
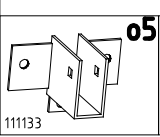
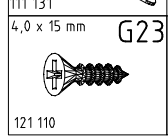
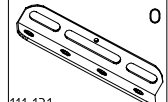
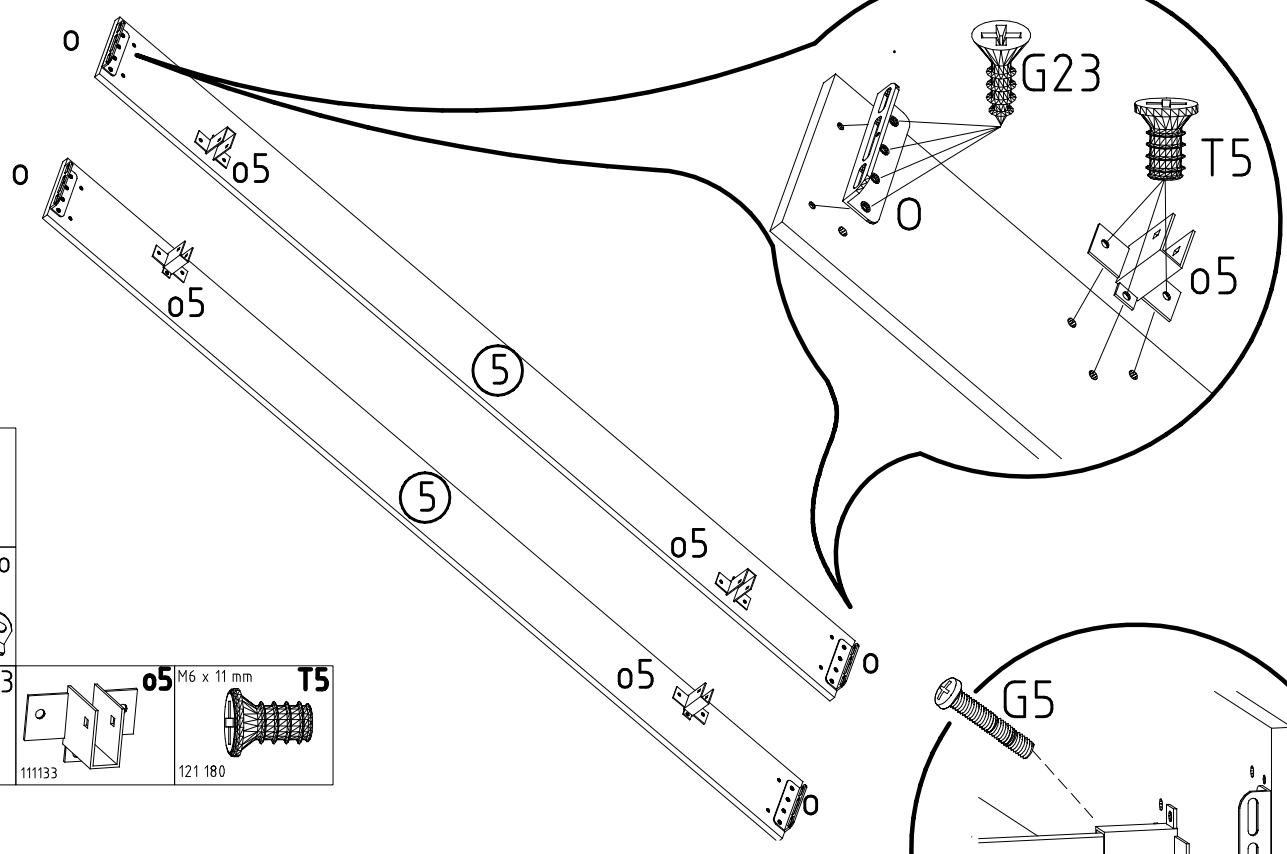

2

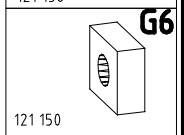
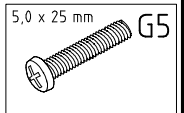
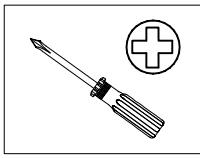
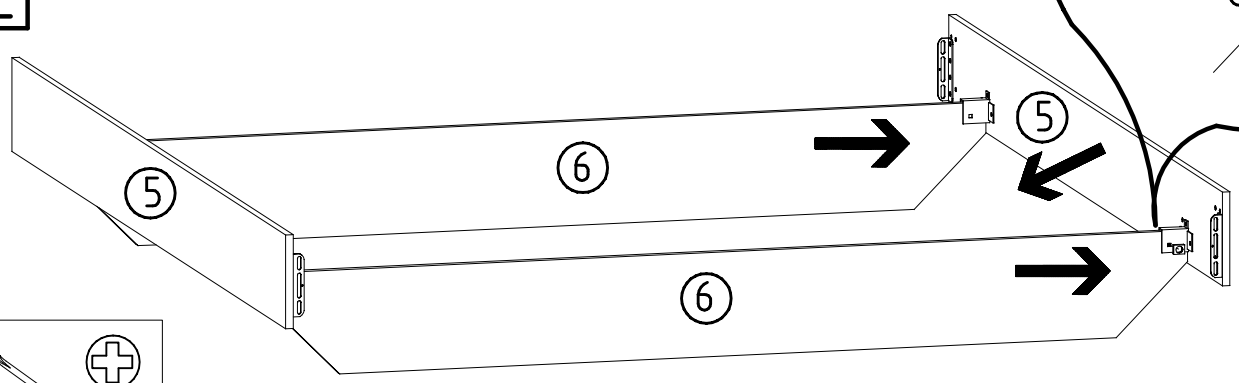

3

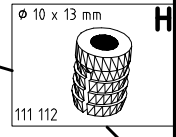
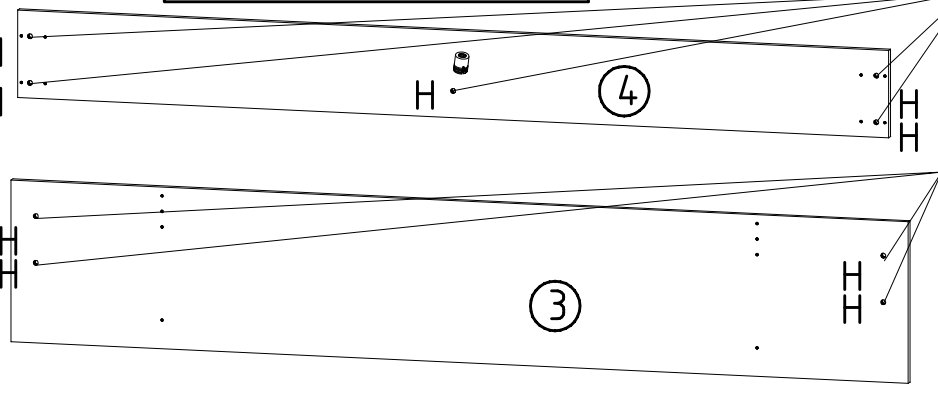
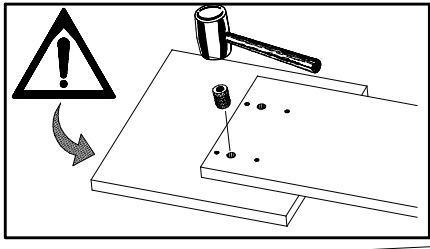

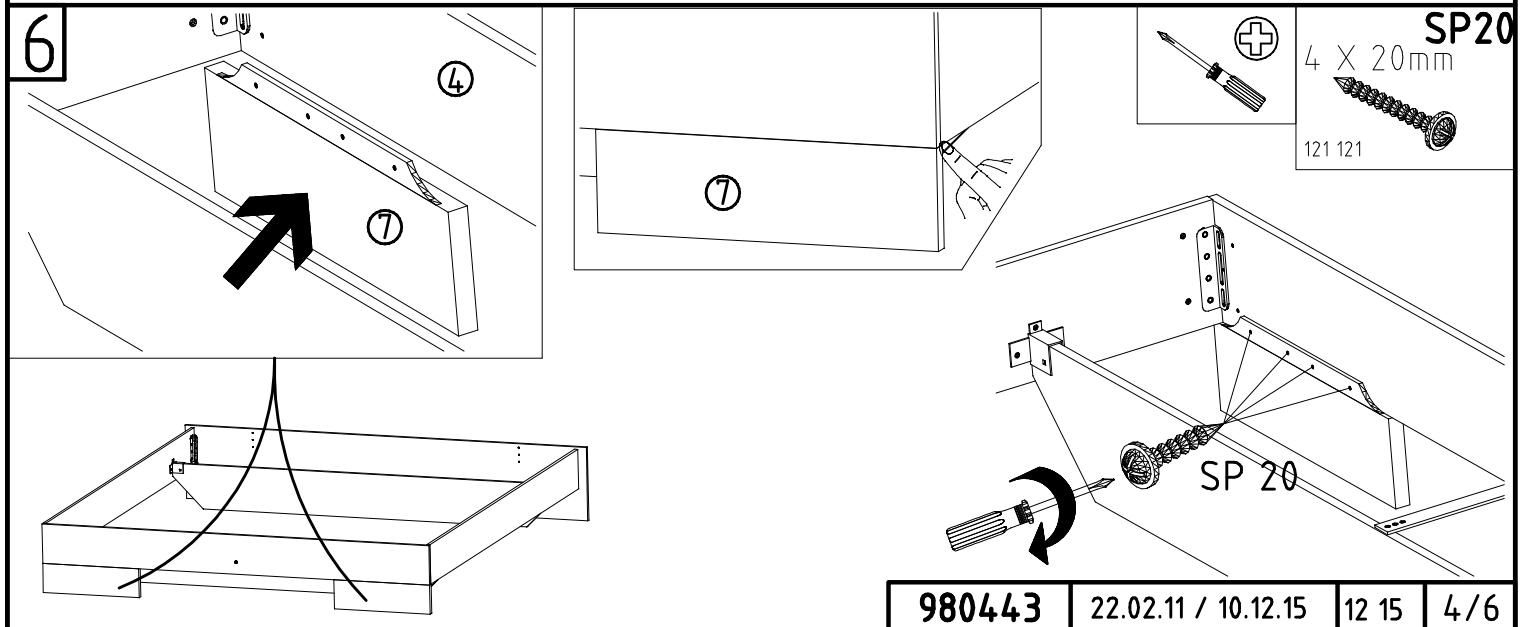
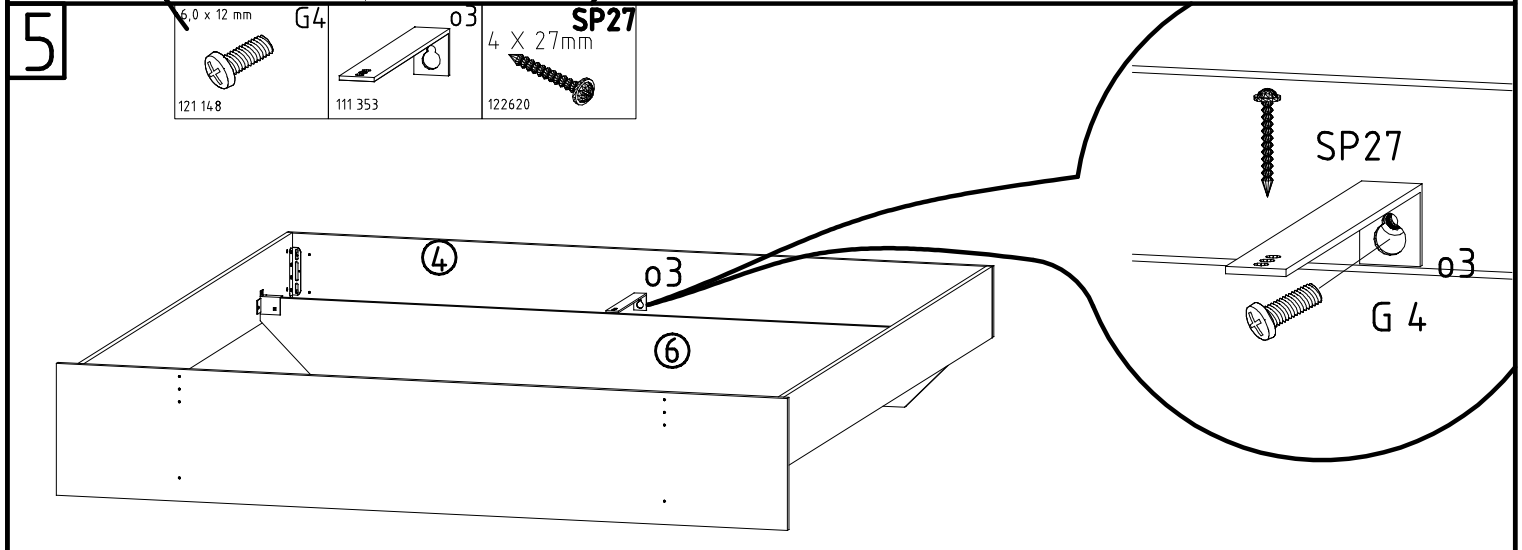
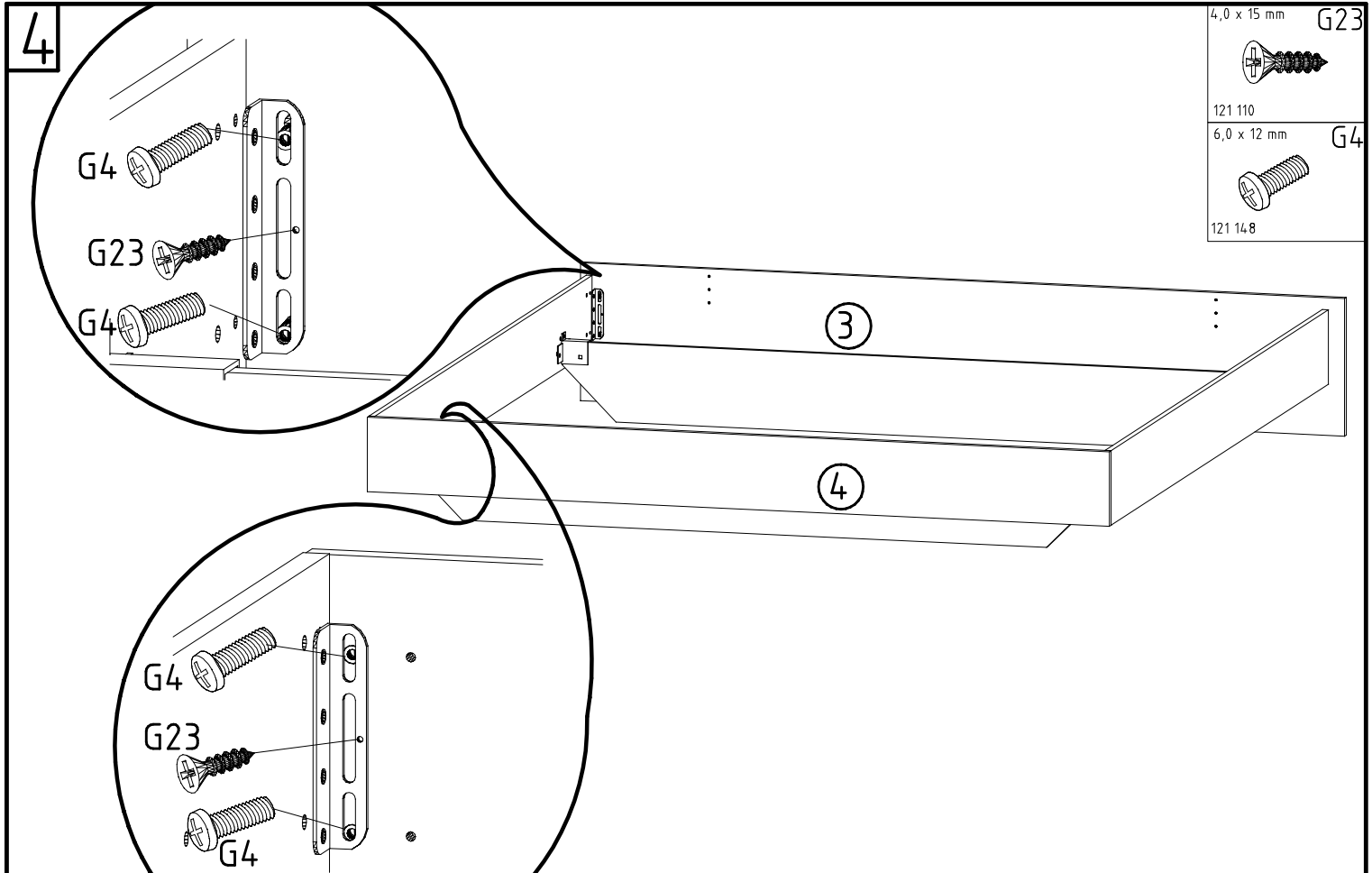

6

L600 (A)

L750 (B+C)

L600 (A)

L750 (B+C)

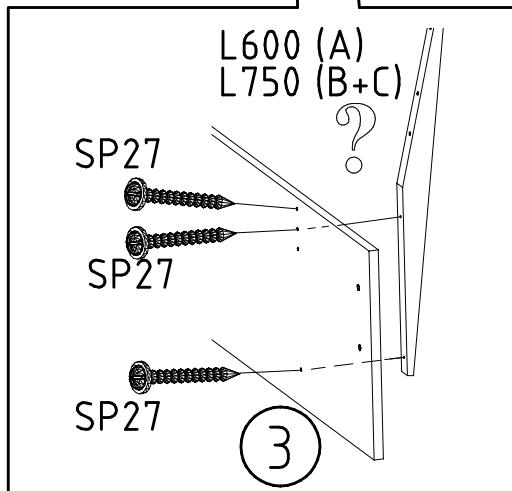
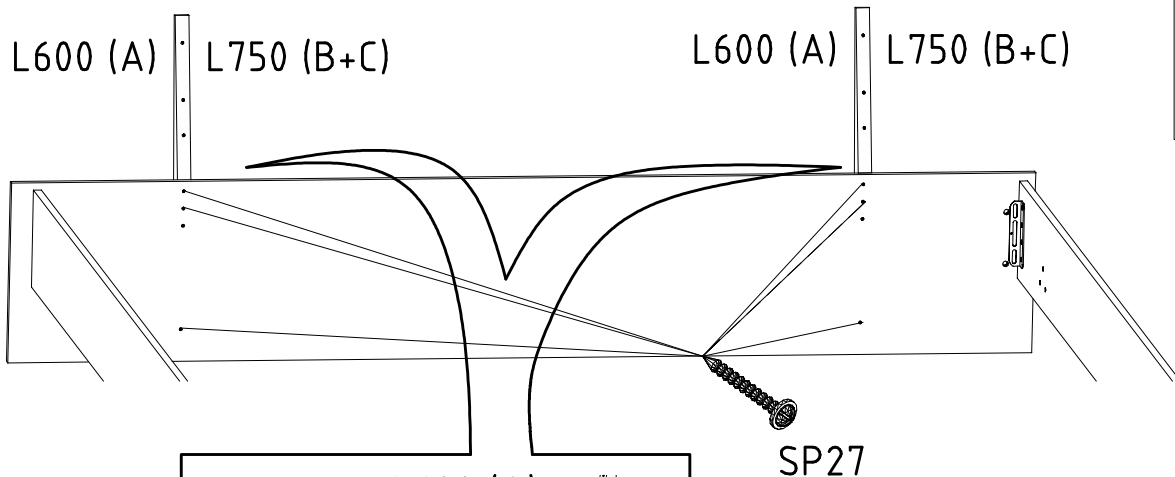

7

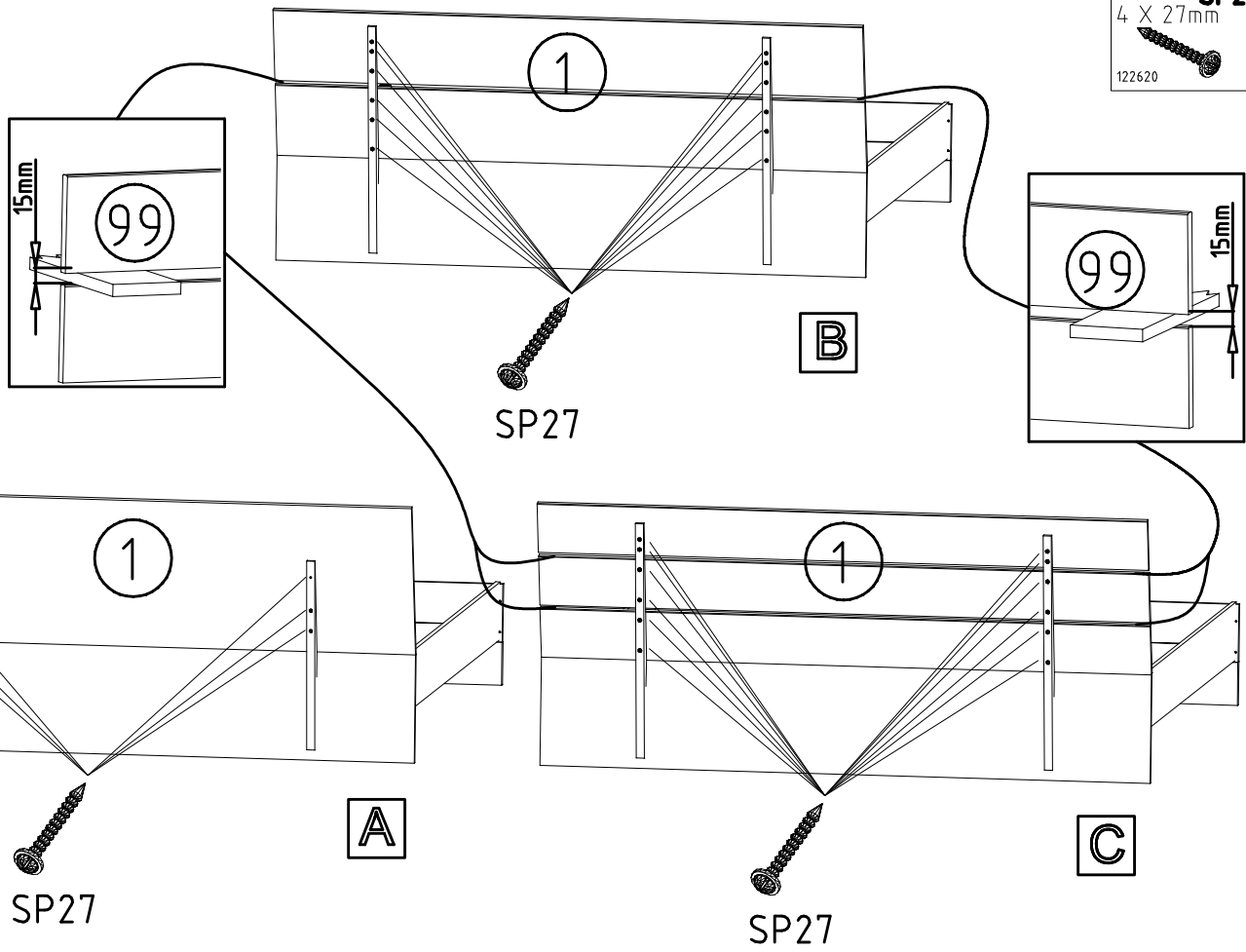

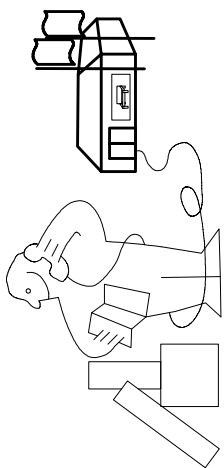
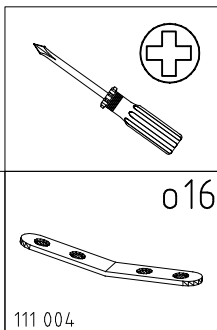
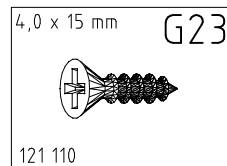
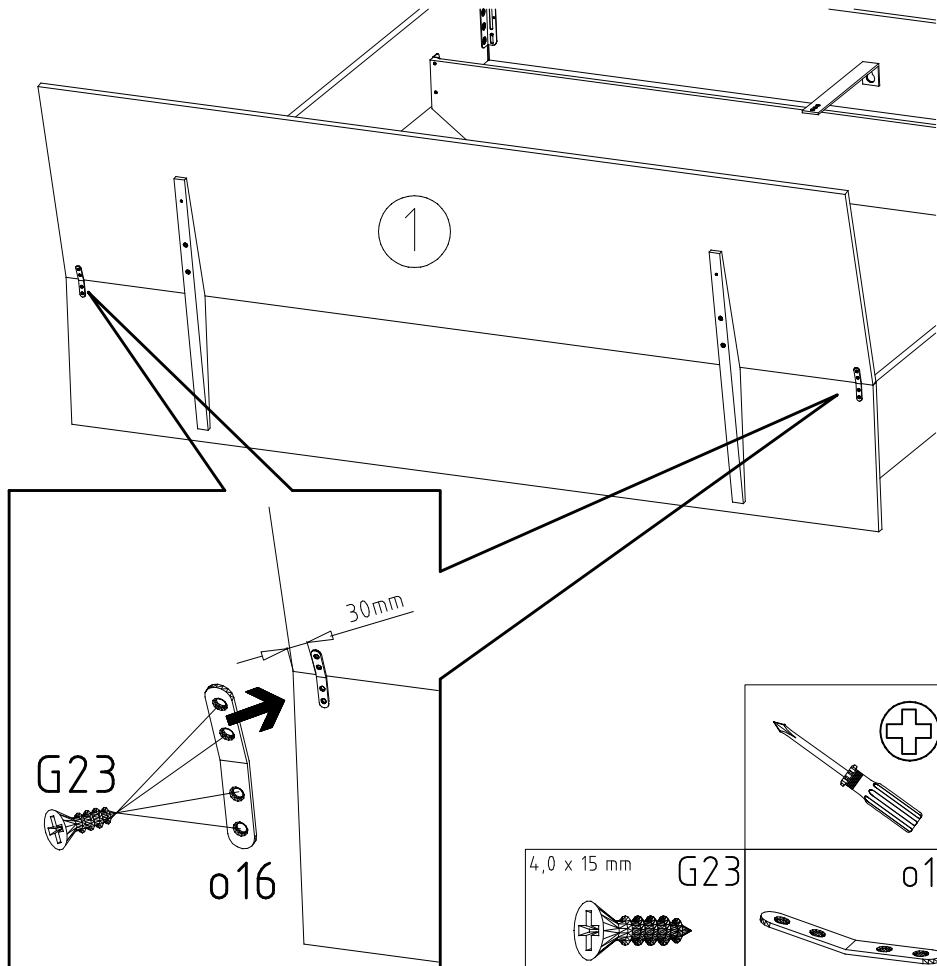
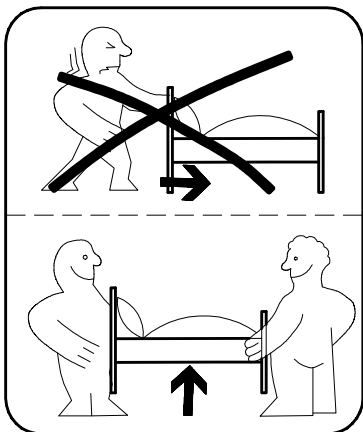
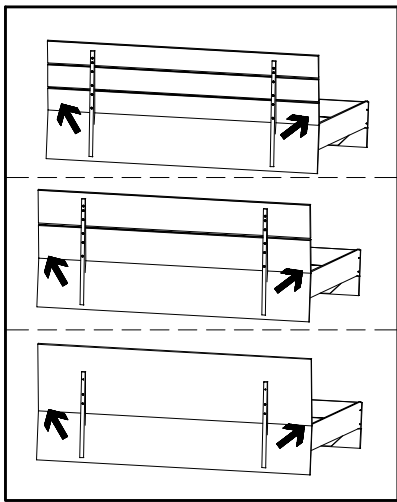

Modell/Model/Modèle

--	--	--	--	--	--	--	--

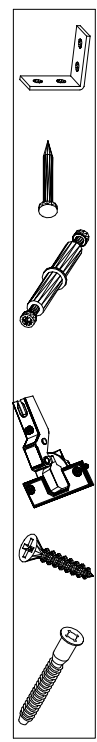
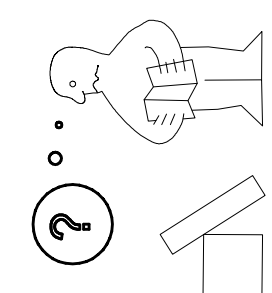
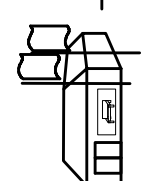
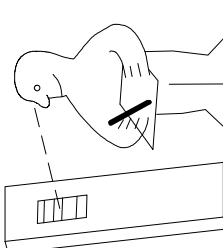

(121 370)	(G 1)	(4x)

Änderungen die dem Technischen Fortschritt geschuldet sind, behalten wir uns vor!
 Bei nicht vorschriftsmäßiger und/ oder nicht fachmännischer Montage wird bei Personen- und/ oder Sachschäden keinerlei Haftung übernommen.

WIMEX Wohnbedarf/ Import Export Handels GmbH/ Postfach 14.07/ 49112 Georgsmarienhütte/ Germany
 Tel.:(+49) 054.01.8598 16/17 Fax.:(+49) 054.01.8598 33 Mail: service_H@wimex-online.com

104P-Nr. / 104P-No. 150X-Nr. / 150X-No. Auftrag/Order-No. / No. de Commande

23203 **30110XY** 104

Kunde MAX MUSTERMANN
Customer
Client

Kommission / your order reference / votre reference

3377 MINDEN

Dekor / Decor Decor / Modell / Modele

F99 **SAMPLE**

F99842 SCHWEBETUERENSCHRANK 250 CM H 216CM
PLANKENEICHE NB + RAU STEEL
PLANKENEICHE NACHBILDUNG

202320301107241476000001

Paket / Package / Paquet

414760

SOCKEL

Paket 1 von 8 Colli Kommission 10

HSP-SMT BOD 50 TEXT/TEX SOCKEL 32 FRESH TV / LF 104
SO-BOD TEXT RASTEX/ ZNBOD D18MM TX KLSTA

Montage - Anleitung Laenge 520,0 OBEREN
KS-64 Breite 568,0 OBEREN

SOCKEL32 KLEB

En cas de dommage, veuillez retourner le carton avec le produit. / En cas de dommage, veuillez retourner le carton avec le produit.



OBEREN 5 30/19 HAUT 23.08.19 OBEREN 1 1. ABOVE OBEREN



WIMEX Wohnbedarf
Import Export Handelsges mbH & Co. KG
Werner-von-Siemens-Str. 35
D-49124 Georgsmarienhütte - Germany

SAMPLE **23.08.19**
Modellname Produktionsdatum
Model Date of manufacture

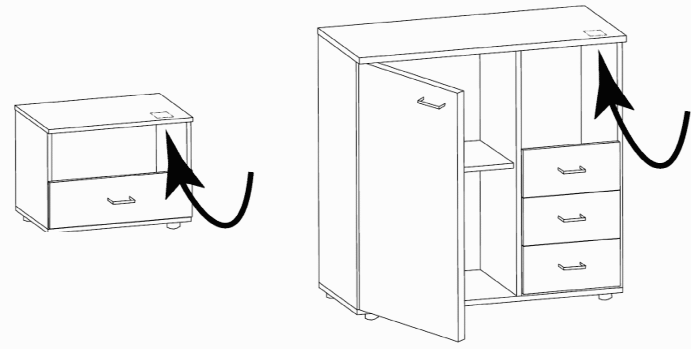
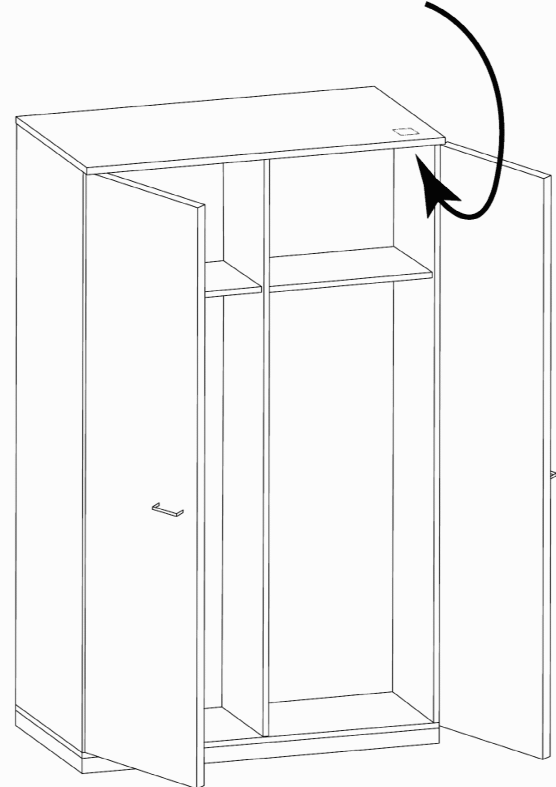
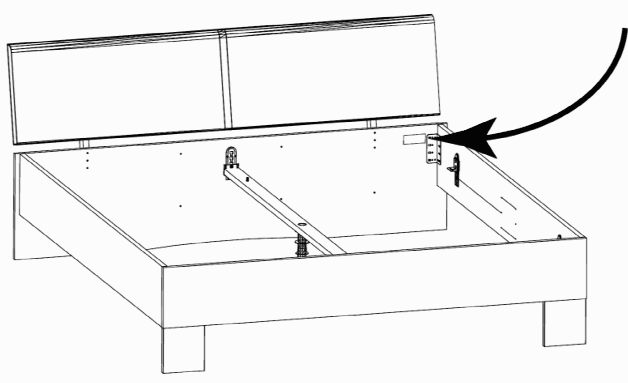

980512

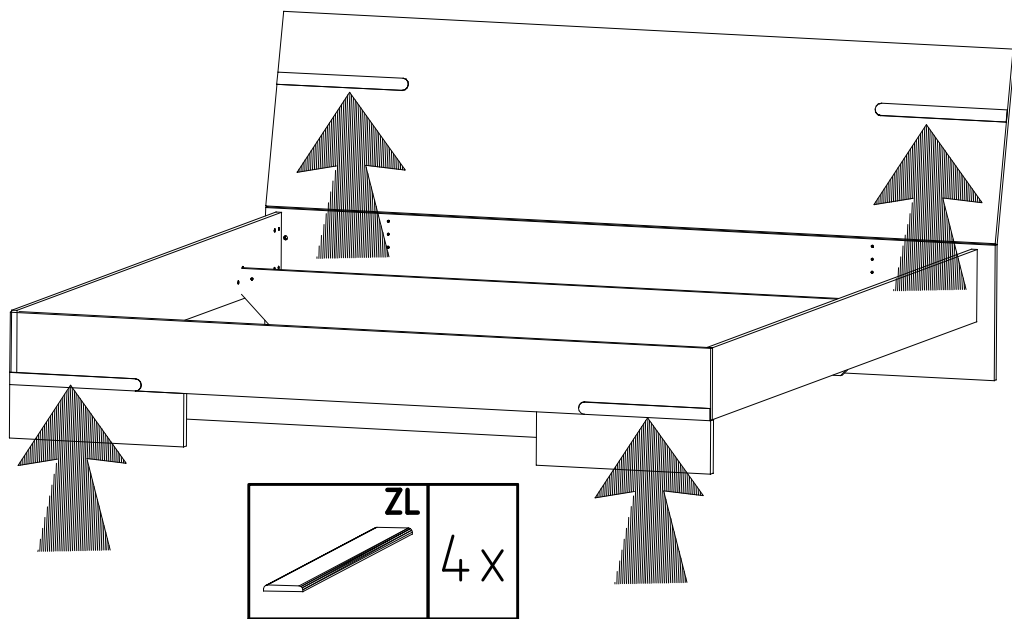
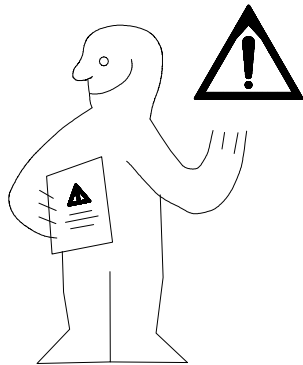

1.

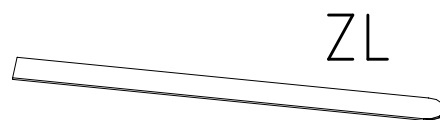
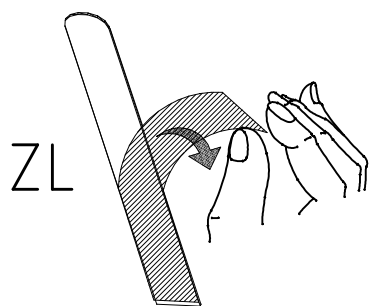

2.

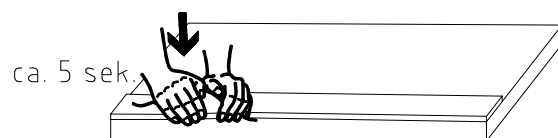
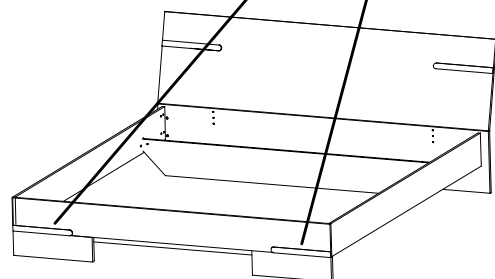
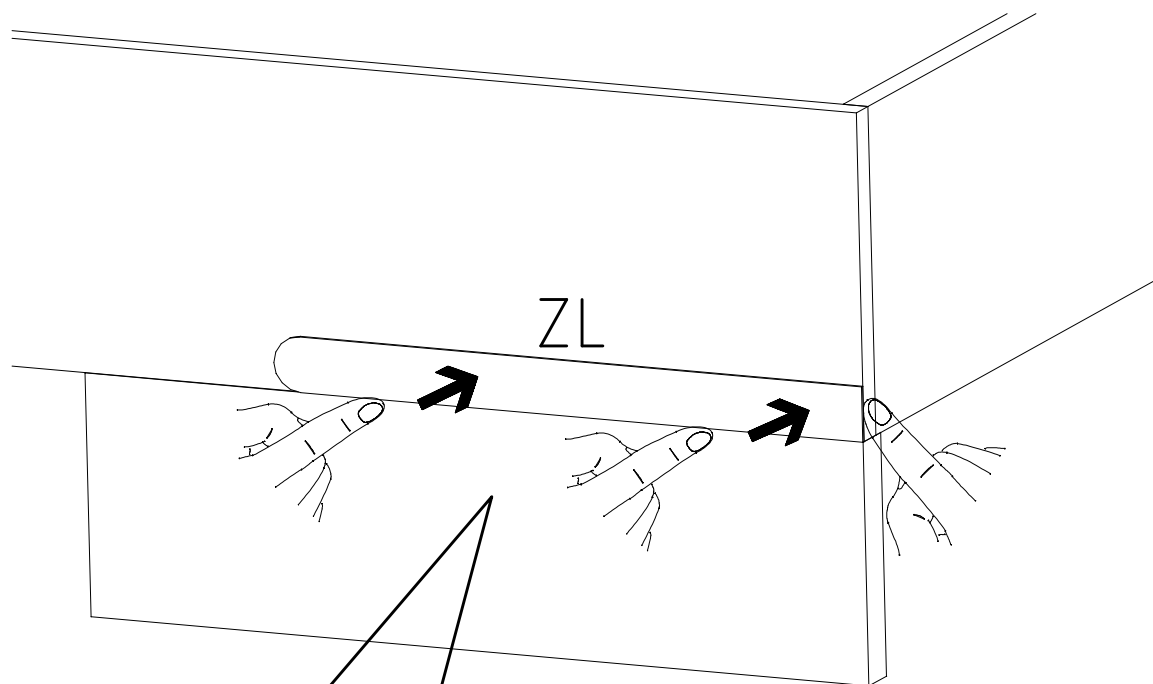

980512

13.02.11 / -

02 12 1/2

3.

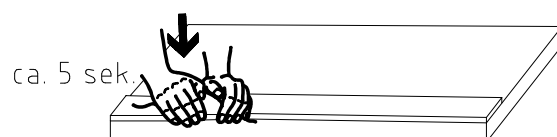
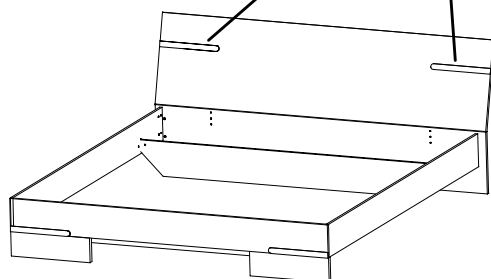
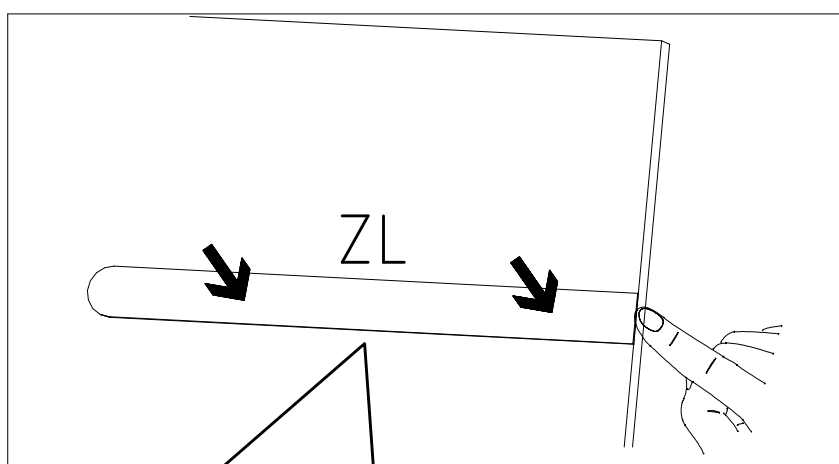
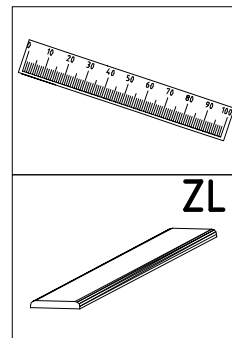
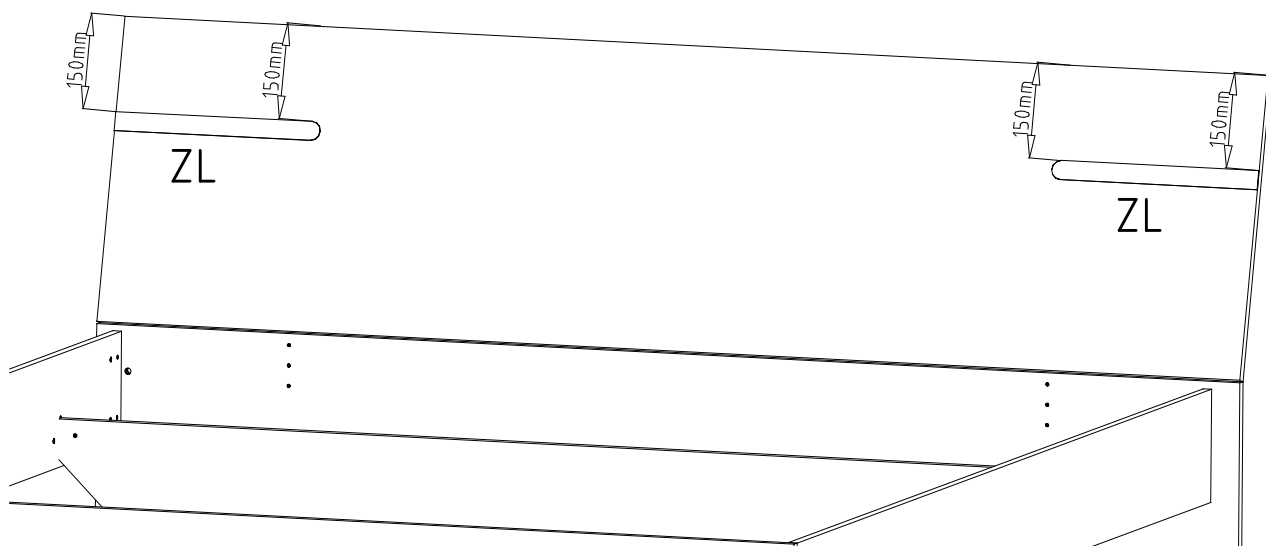

4.

