

980742

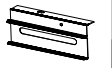

1.

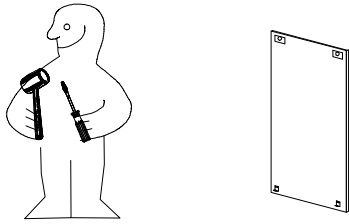

2.

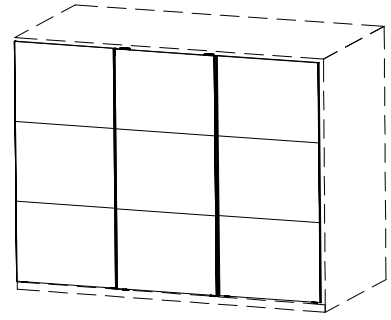
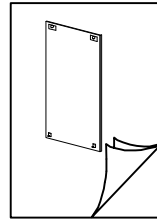
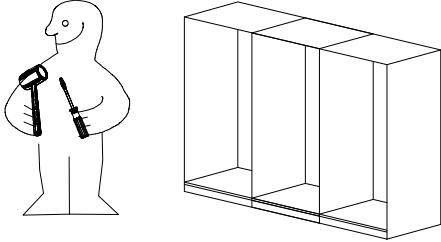

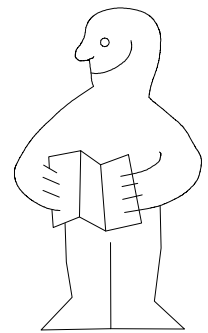
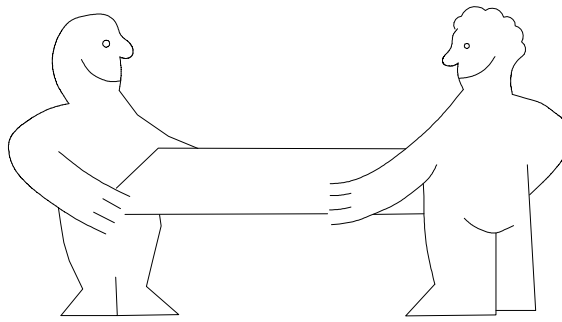
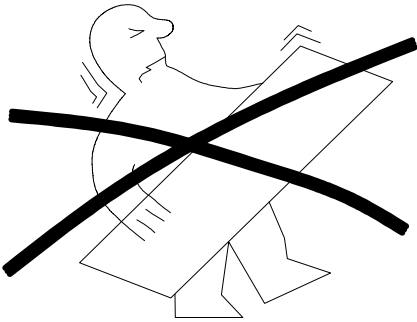

300 HSP 3Trg



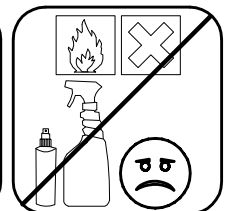
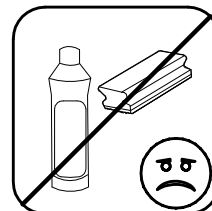
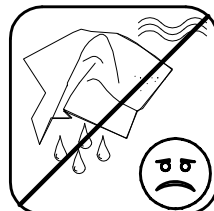
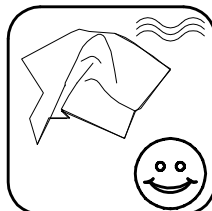
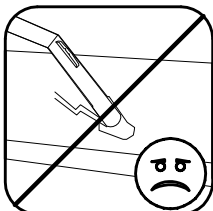
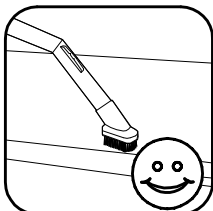
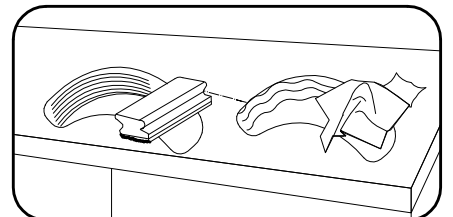
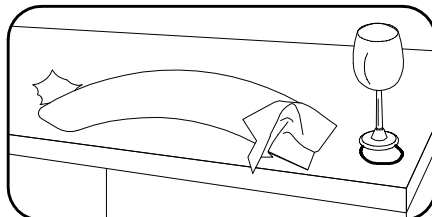
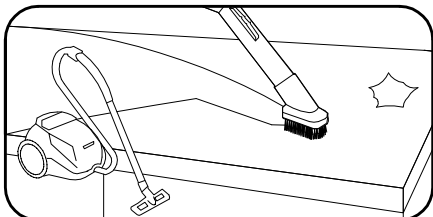
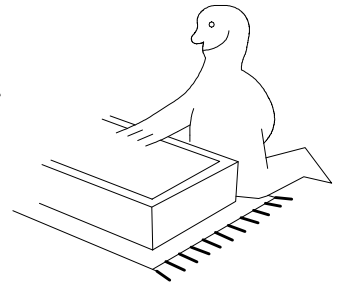
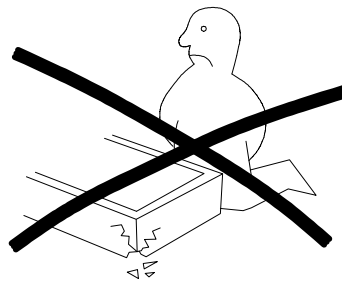
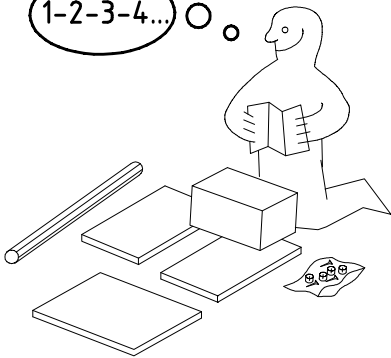

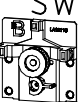
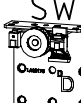
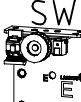
1-2-3-4... ○ ○

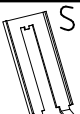

SW-LA  LA12117	2x
SW-LB  LA12116	2x
SW-LD  LA12175	1x
SW-LE  LA12176	1x

SW-F1 	6x
SW-F2 	4x
SW-F3 	2x

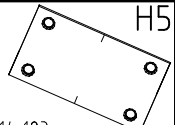
SP13 4 X 13mm 	96x
121 122 6,3 x 10,5 mm T2 	38x
111 030 H5 	6x
114 183	

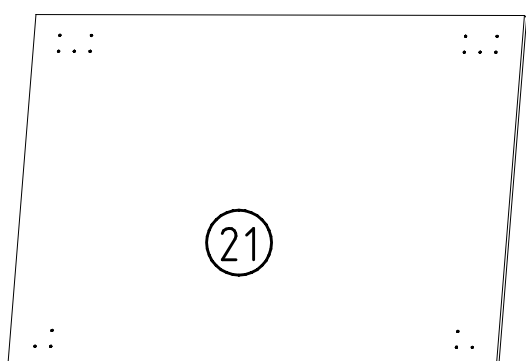
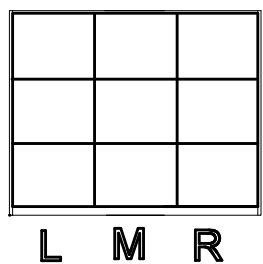
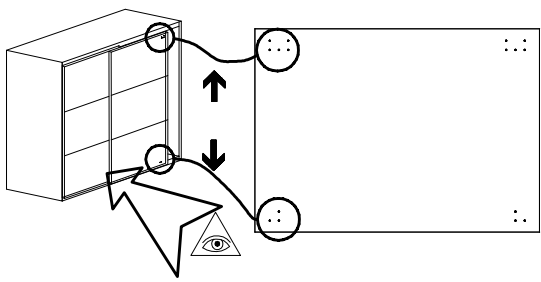
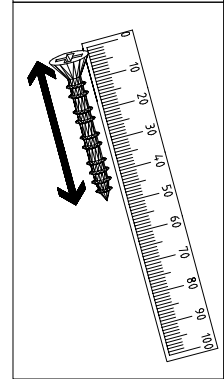
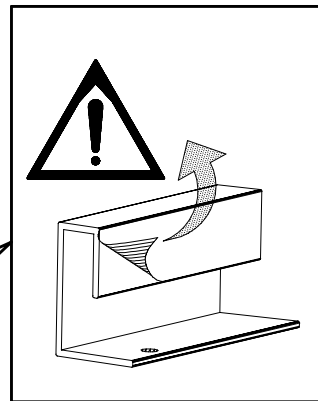
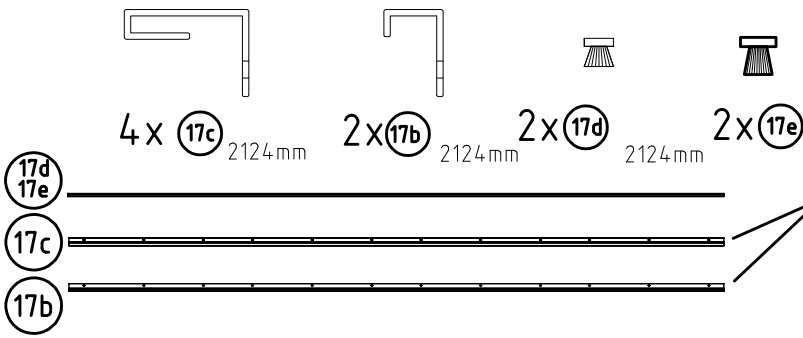
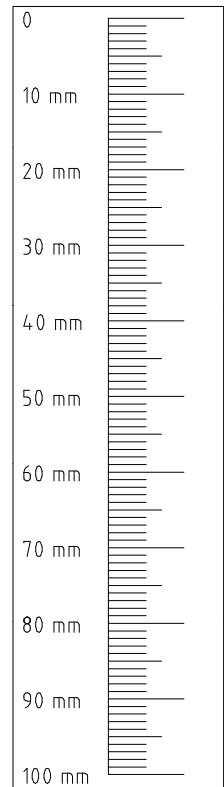
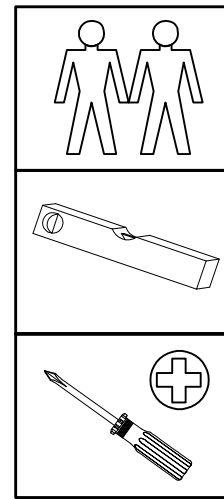

9x 990x 708 x 15

1

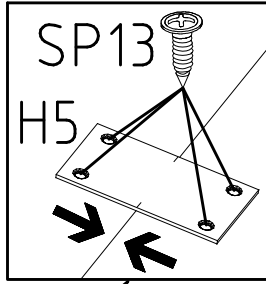
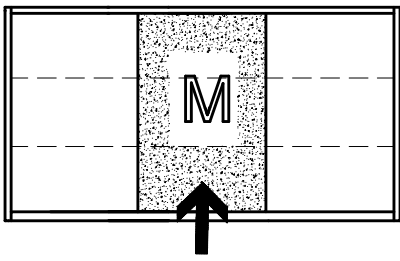

H5 4 X 13mm SP13
 114 183 121 122

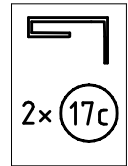
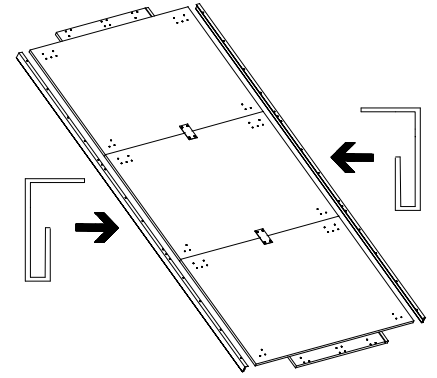
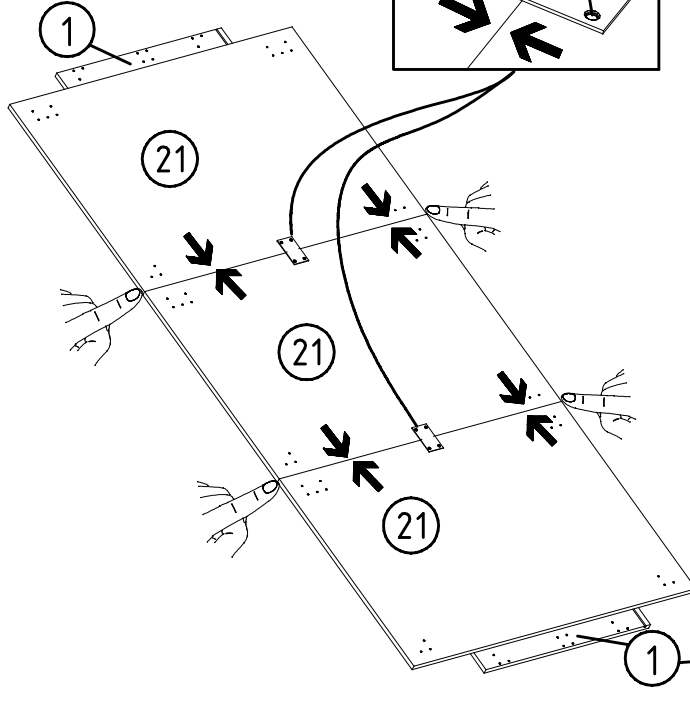
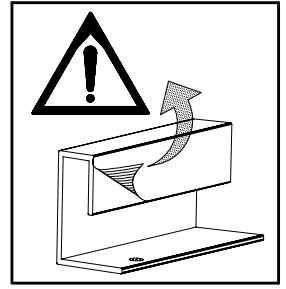

2

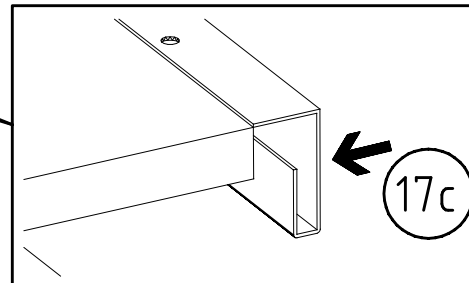
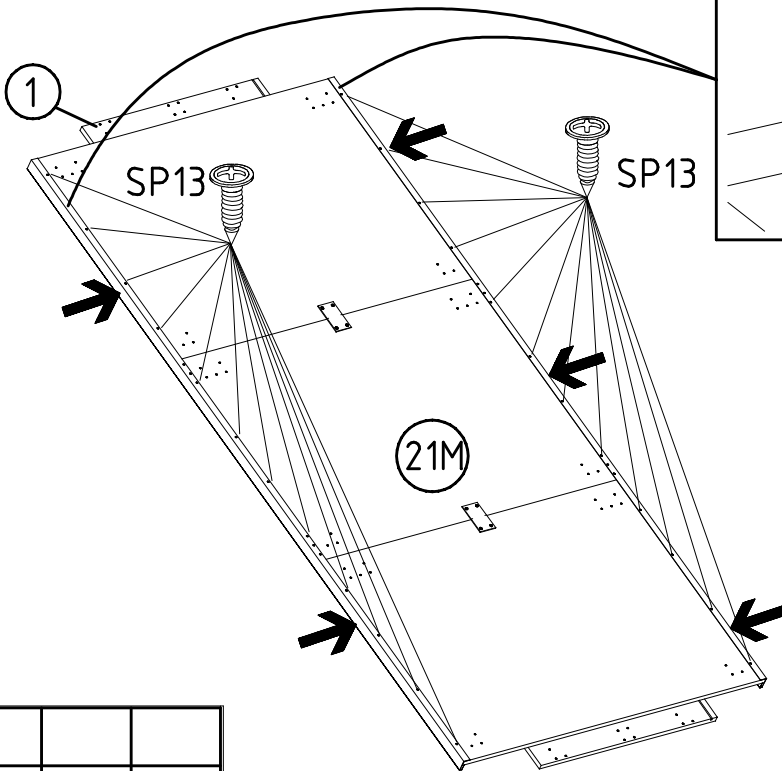

SP13 4 X 13mm
 121 122

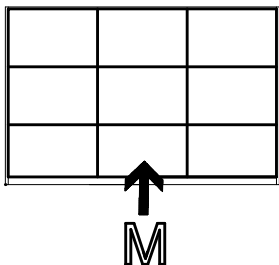

3

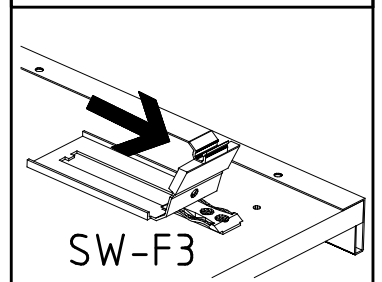
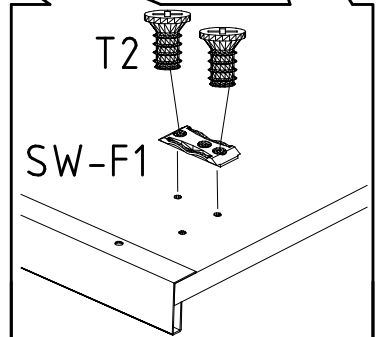
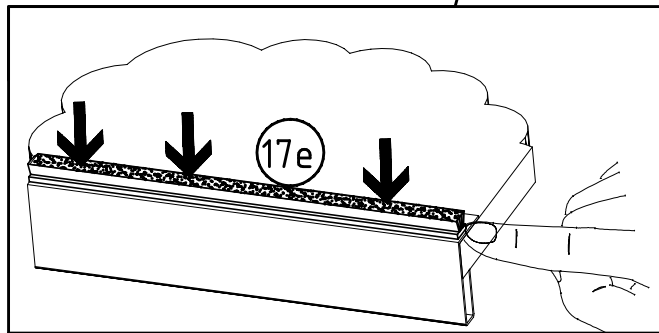
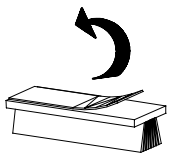
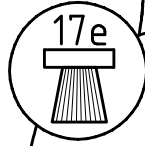
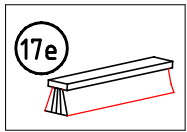
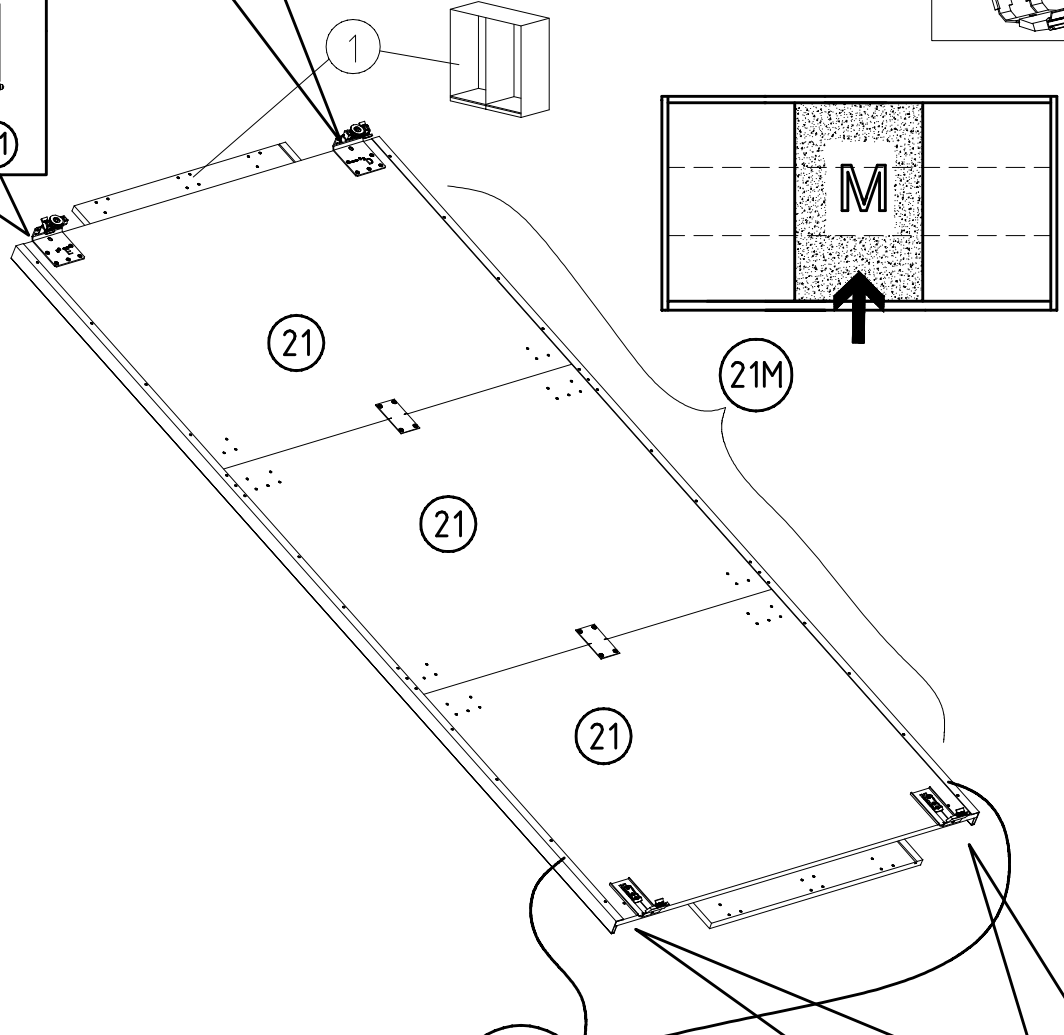
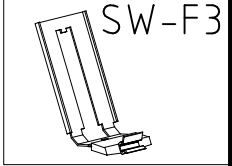
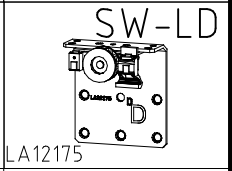
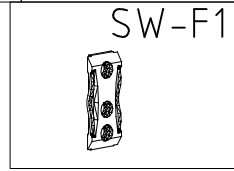
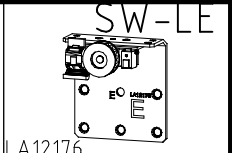
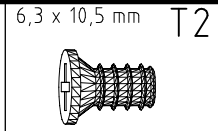
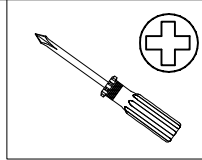
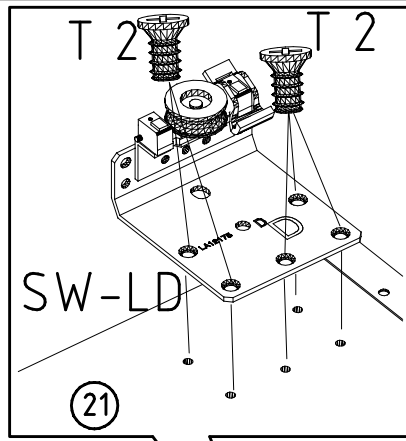
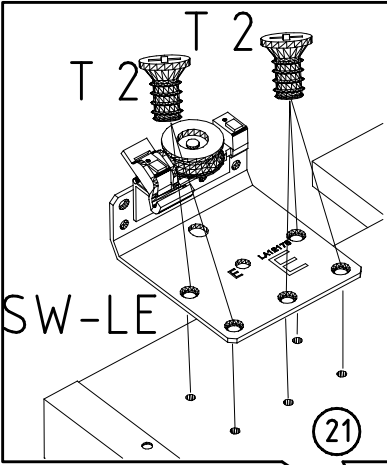

4

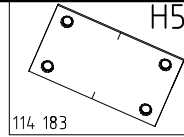
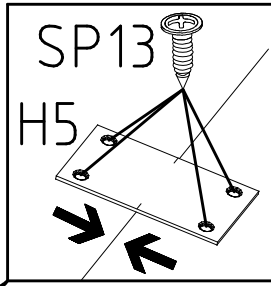
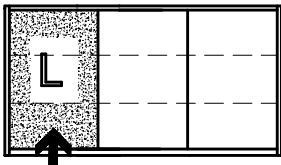

4 X 13mm
SP13
121 122

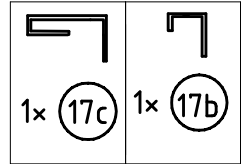
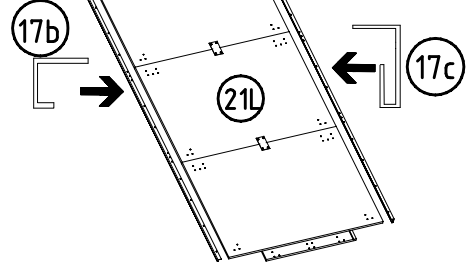
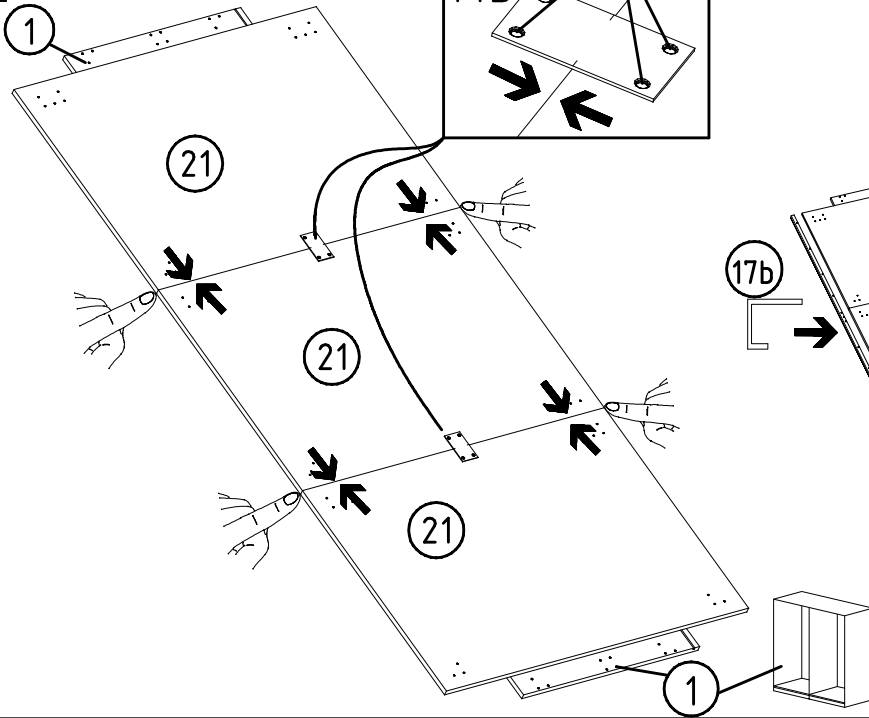
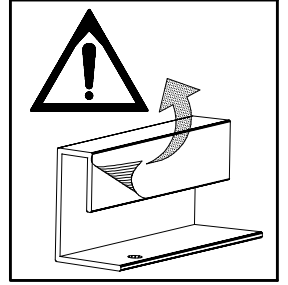
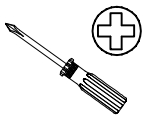

5

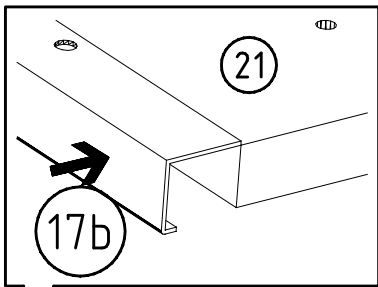

4 X 13mm
SP13
121 122

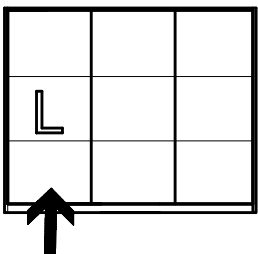
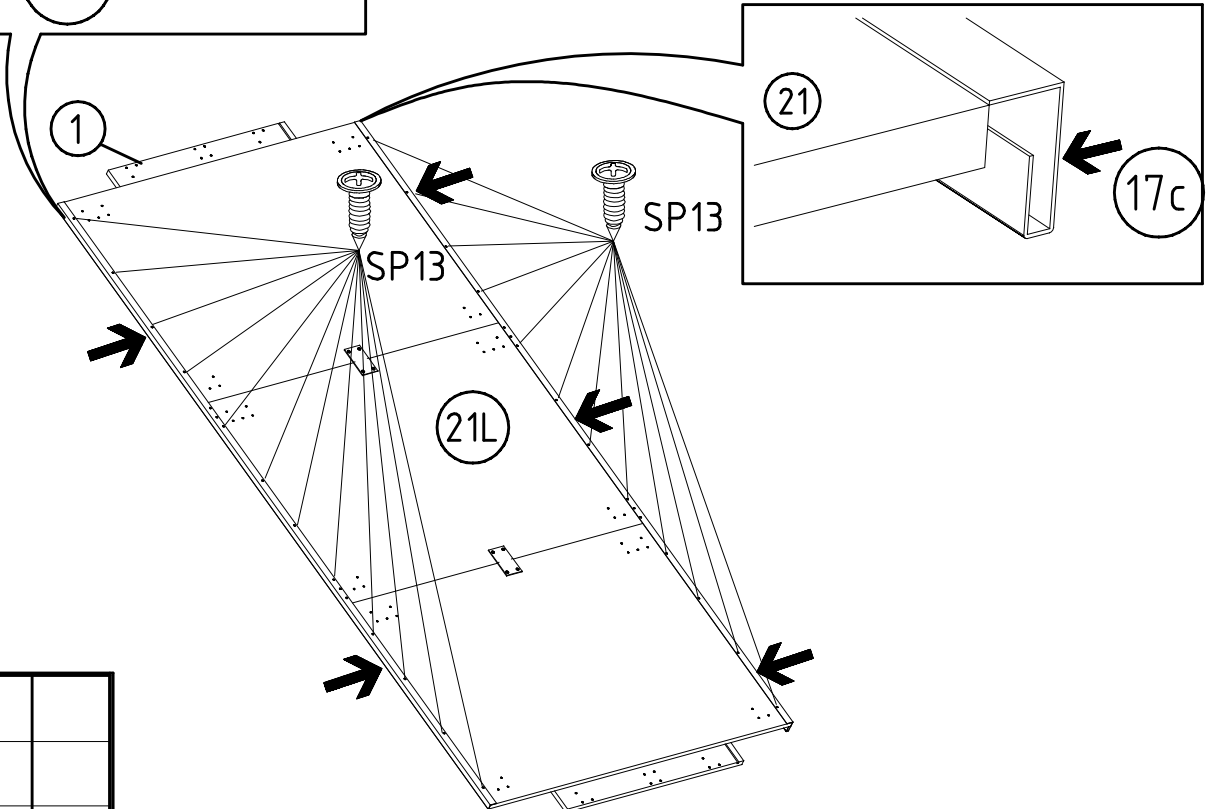
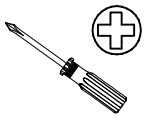

6

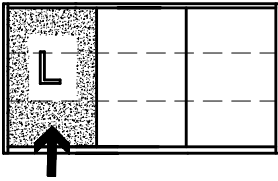
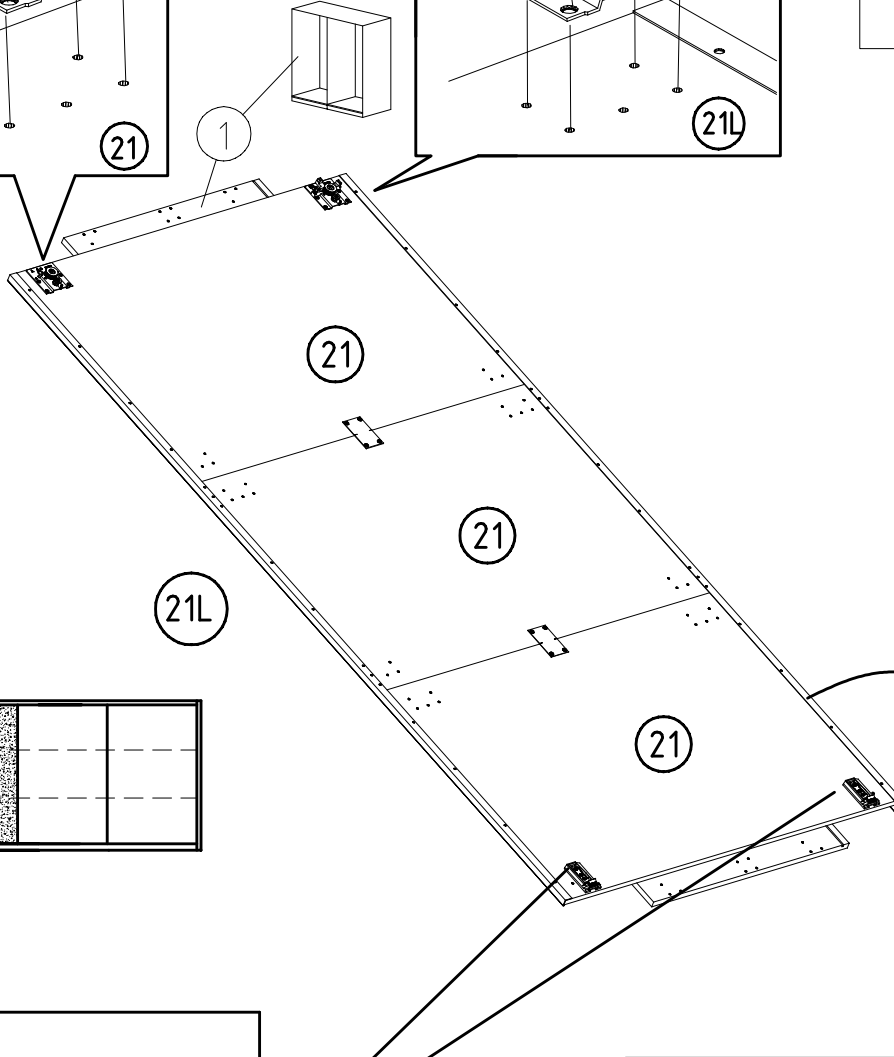
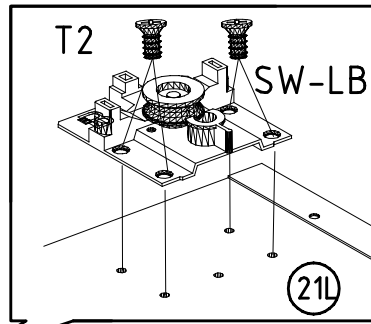
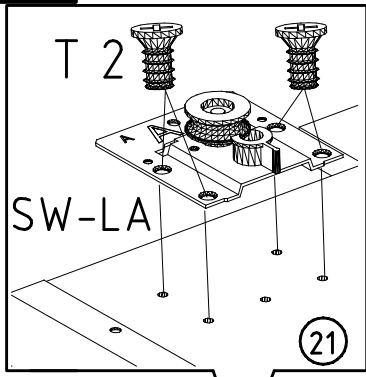

SW-F1 	SW-LA LA12117
SW-F2 	SW-LB LA12116
6,3 x 10,5 mm T2 	

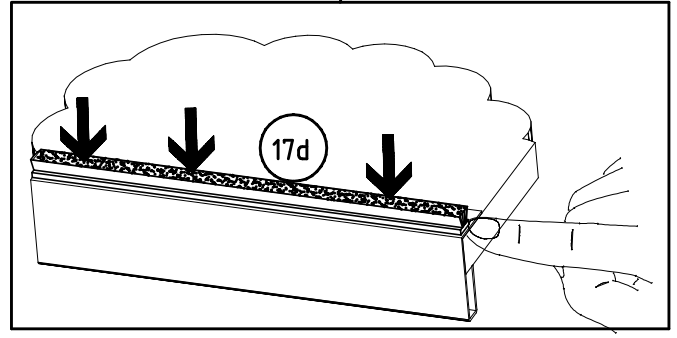
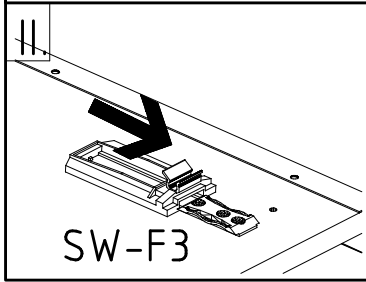
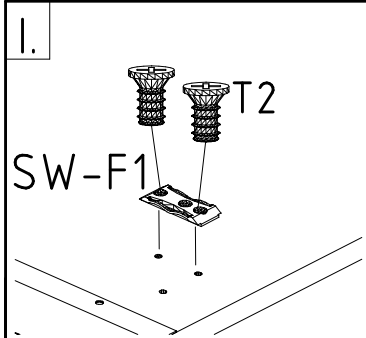
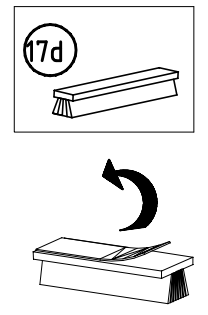

7

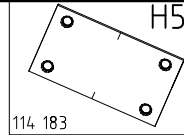
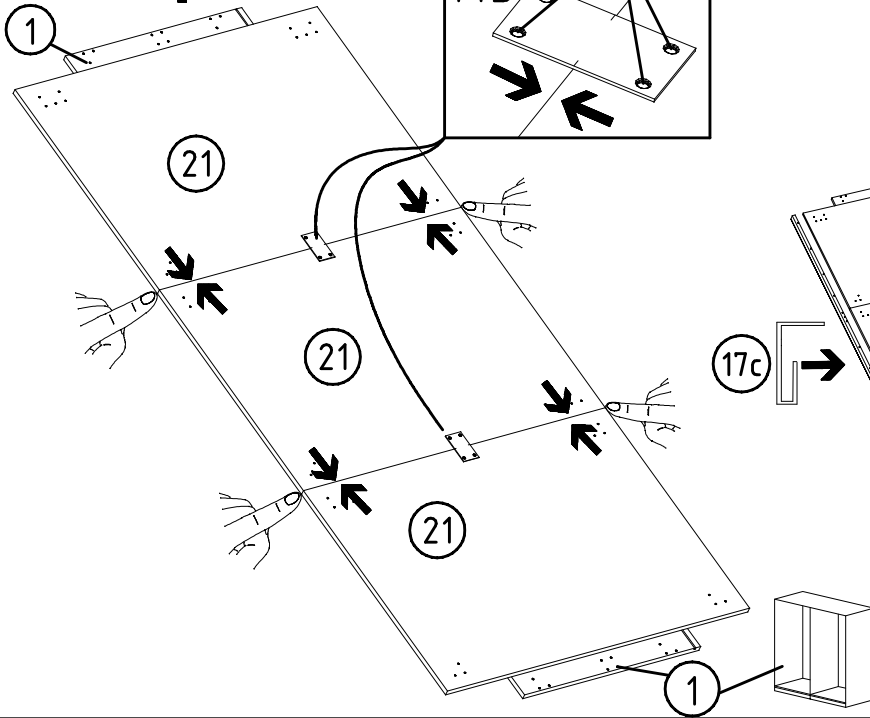
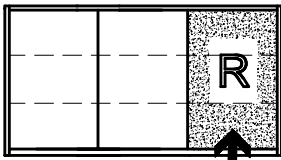

SP13
4 X 13mm
121 122

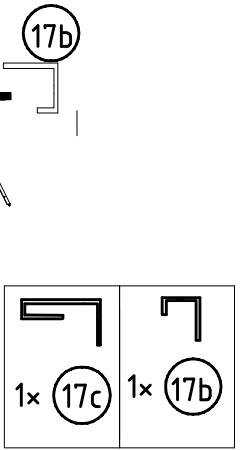
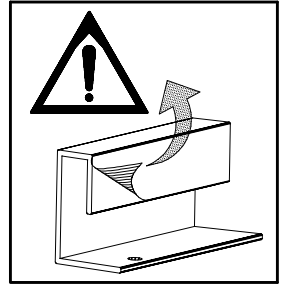
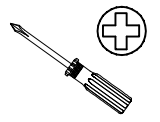

8

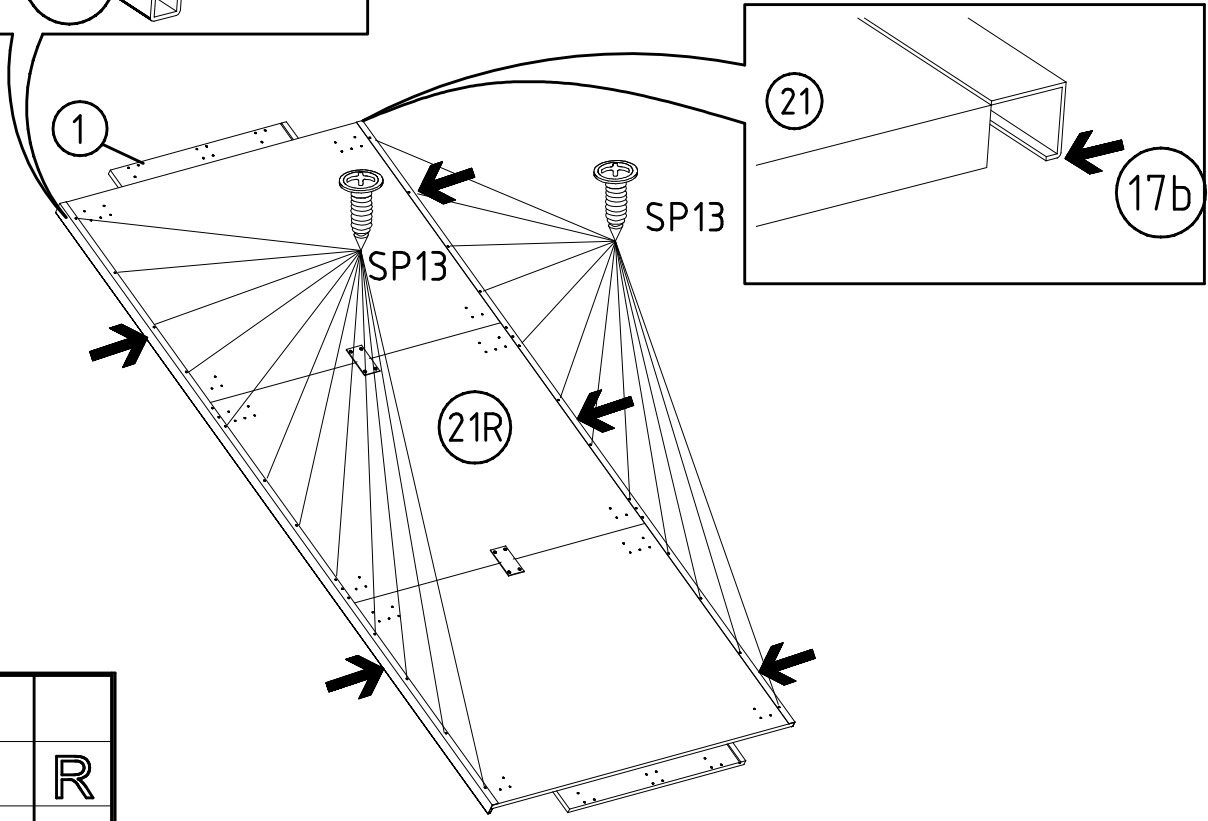
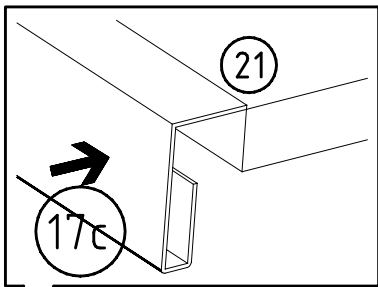

SP13
4 X 13mm
121 122

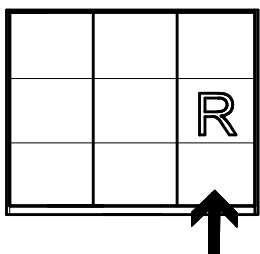

9

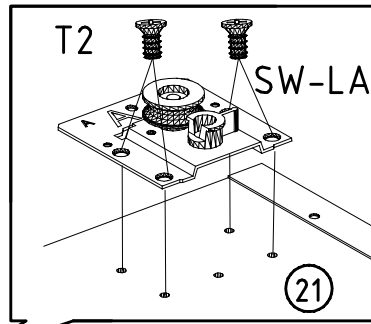
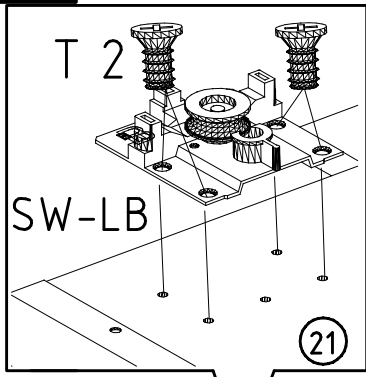

SW-F1 	SW-LA LA12117
SW-F2 	SW-LB LA12116
6,3 x 10,5 mm T2 	

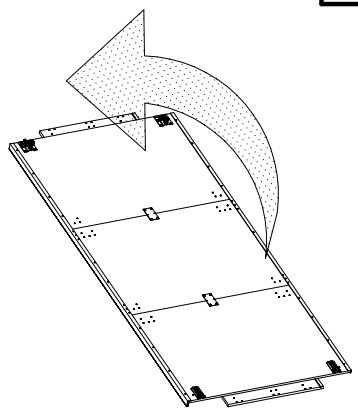
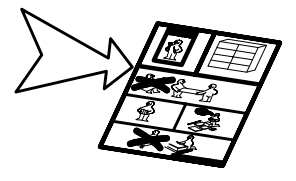
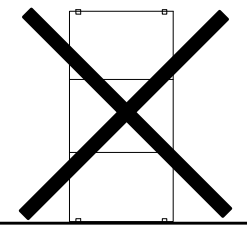
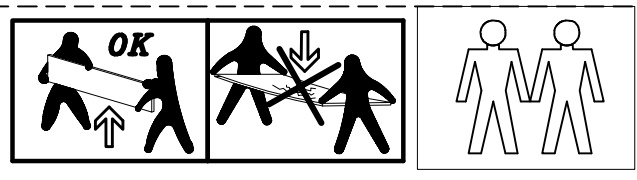
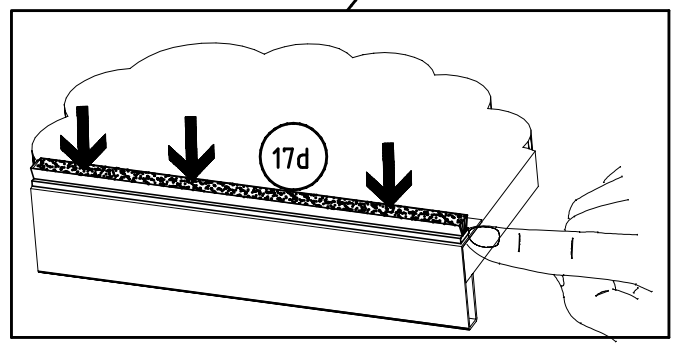
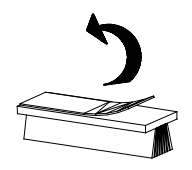
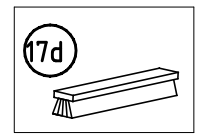
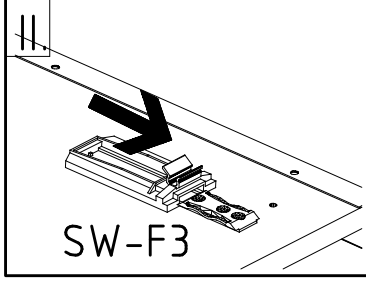
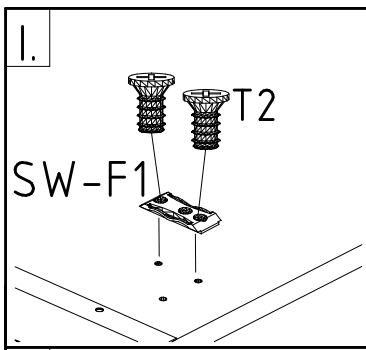
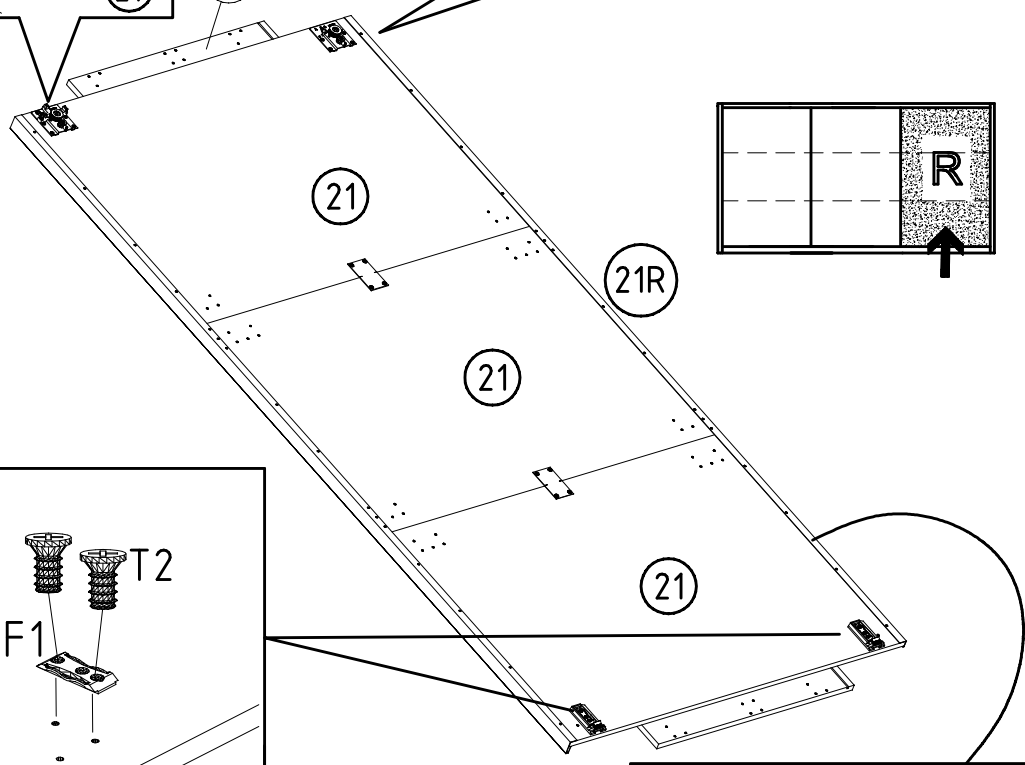

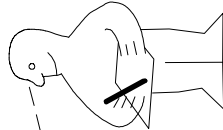
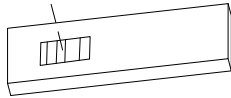
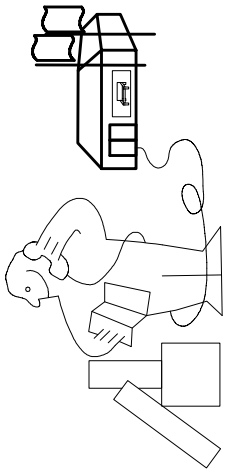
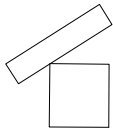
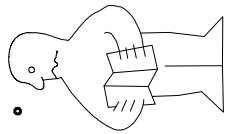

Modell/Modèle

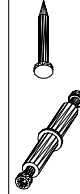
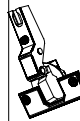
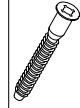
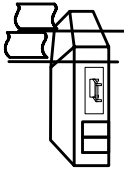
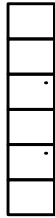
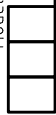

<121 370>	< G 1 >	<4x>

Änderungen die dem technischen Fortschritt geschuldet sind, behalten wir uns vor!
 Bei nicht vorschriftsmäßiger und/ oder nicht fachmännischer Montage wird bei Personen- und/ oder Sachschäden keinerlei Haftung übernommen.

made by

WIMEX Wohnbedarf Import Export Handels GmbH & CoKG/ Postfach 14/07/ 49112 Georgsmarienhütte/ Germany